

INSTRUCTION MANUAL

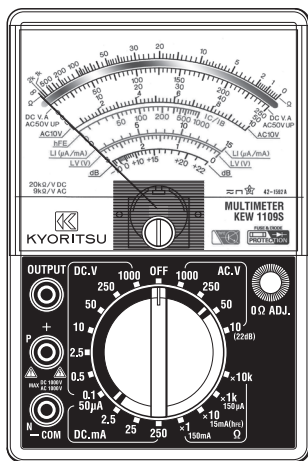

ANALOGUE MULTIMETER

KEW 1109S



**KYORITSU ELECTRICAL
INSTRUMENTS WORKS, LTD.**

Table of Contents

	Page
1. Safety Warnings	1
• Understanding Some of the Basics in Electrical Testing Before Using the Multimeter	3
2. Features	5
3. Specifications	6
4. Instrument Layout	8
5. How to Read Scales	9
6. Operating Instructions	11
6-1 Preparation	11
6-2 DC Voltage Measurements	12
6-3 AC Voltage Measurements	13
6-4 Low Frequency (dB) Measurements	14
6-5 AC Output Voltage Measurements Using Output Terminal	15
6-6 DC Current Measurements	16
6-7 Resistance Measurements	17
6-8 Terminal Current LI, Terminal Voltage LV & Diode Test	20
6-9 Measuring I_{CEO} (leakage current of transistors)	22
6-10 Measuring h_{FE} (DC Current Amplification Factor)	24
7. Fuse & Battery Replacement	27

1. Safety Warnings

The instrument must be used by a competent, trained person and operated in strict accordance with the instructions. Kyoritsu Electrical Instruments Works, Ltd will not accept liability for any damage or injury caused by misuse or non-compliance with the instructions or safety procedures. It is essential to read and understand the safety rules contained in the instructions. They must be observed when using the instrument.

- **This instruction manual contains warnings and safety rules which must be observed by the user to ensure safe operation of the instrument and retain it in safe condition for a long period. Therefore, read these operating instructions thoroughly and completely before using the instrument.**

⚠ WARNING

This is a warning for the user to avoid electric shock hazard.

The symbol ⚠ on the instrument means that the user must read the instructions in this manual for safe operation of the instrument.

⚠ CAUTION

This is a caution for the user to avoid damage to the instrument.

⚠ WARNING

- **Never open the back case during measurements.**
- **Never use the instrument to measure voltage higher than 250V on an industrial power line.**
- **When measuring a high voltage greater than 250V (in small power supply circuit and not on power transmission line), connect the test leads to the circuit under test after it is once de-energized. Do not touch the wiring or test leads by hand during voltage measurements. After the measurements, turn off power to the circuit under test and disconnect the test leads. Never test a circuit voltage higher than 250V with the range selector switch erroneously set to one of the current or resistance range positions. The fuse may not protect the circuit.**

- **Never use the instrument in an explosive atmosphere especially when making current measurements.**

⚠ CAUTION

- **Before making measurements check that the range selector switch is at a proper range position. Make sure to remove the tips of the test leads from the circuit under test when changing the measuring range during measurements.**
- **Do not apply voltage to the current or resistance ranges. It may result in a fuse blow or instrument damage.**
- **Make certain to set the range selector switch to the OFF position after every use.**
- **It is recommended that the range selector switch should be set to the 250mA DC position to protect the instrument against the possible shock or vibration in transit.**

Note: Take good care not to make voltage measurements with the range selector switch at the 250mA DC position. The fuse may blow or instrument get damaged.

- **Do not expose the instrument to the direct sun, extreme temperature and humidity or dew fall for a long period. Also, care must be taken not to give a shock to the instrument by dropping or inadequate handling.**
- **Since the meter cover has been given an anti-static treatment do not rub it strongly with a dry cloth. Where anti-static charges are present on the meter window after it has been used for a long period of time, causing the meter pointer to deflect in an abnormal way, coat its surface with anti-static chemicals for plastics or wipe it with a dilute solution of anti-static fluid as a temporary measure.**
- **Understanding Some of the Basics in Electrical Testing Before Using the Multimeter**

- Auxiliary Units (Prefixes)

There are a number of measurement units used for multimeters.

Volt (V), ampere (A) and ohm (Ω) are most widely used as measurement units to indicate electrical potential, current and resistance. However, it is not always straightforward to handle these units as they sometimes too large or too small for practical use or calculation. Prefixes are therefore used as auxiliary units to simplify the usage of such measurement units.

The following table shows some of the examples:

Auxiliary Unit	M	k	m	μ	n	P
Read	mega-	kilo-	milli-	micro-	nano-	pico-
Multiply	10^6	10^3	10^{-3}	10^{-6}	10^{-9}	10^{-12}
Example	2M Ω	2k Ω	250mA	50 μ A	200nF	1000pF
	 2000k Ω	 2000 Ω	 0.25A	 0.05mA	 0.2 μ F	 0.001 μ F

- Notes on Voltage & Current Measurements

It is important to understand the basic differences between current and voltage measurements for proper use of multimeters.

Voltage measurements are designed to detect potential difference between two points. Make certain that the multimeter is connected in parallel with the circuit under test.

Current measurements are intended to monitor the consumption of current in the circuit resulting from the application of voltage. Make sure to connect the multimeter in series with the circuit under test.

Generally speaking, the internal resistance of a voltmeter should preferably be larger, while that of an ammeter should be smaller. If the multimeter is erroneously connected in parallel with a circuit for current measurements, the likely result will be the flow of excessive current and subsequent damage to the fuses and other electronic components. To avoid such a potential danger it is necessary to have a good understanding of voltage and current measurements.

Voltage Measurements
(Parallel Connection)

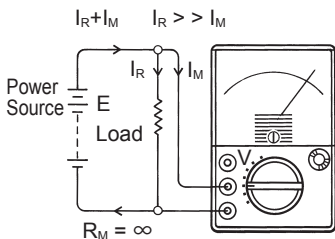

Current Measurements
(Series Connection)

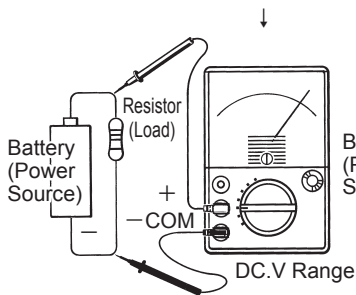
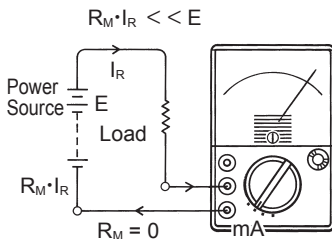

Measuring voltage at both ends
of a resistor.

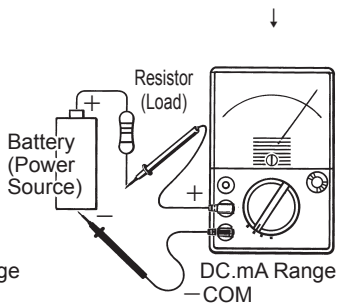

Measuring current being
consumed by a resistor.

I_M Meter Current

I_R Load Current

E Power Source Voltage

R_M Internal Resistance of Multimeter

Fig. 1

2. Features

- Mirrored scale for easy and accurate reading.
- 19 measuring ranges for a wide scope of application.
- OUTPUT terminal to cut off the DC component of AC voltage being measured.
- h_{FE} scale for transistor checking.
- dB scale (-10 - +62dB).
- Safety designed input terminals and test leads.

3. Specifications

Functions	Measuring Ranges	Accuracy
DC Voltage (7 ranges)	0-0.1 V 0-0.5V 0-2.5V 0-10V (20kΩ/V) 0-50V 0-250V 0-1000V	±3% of full scale
	0-10V	
AC Voltage (4 ranges)	0-50V (9kΩ/V) 0-250V 0-1000V	±3% of full scale
DC Current (4 ranges)	0-50μA (terminal voltage approx. 100mV) 0-2.5mA (terminal voltage approx. 100mV) 0-25mA (terminal voltage approx. 150mV) 0-250mA (terminal voltage approx. 550mV)	±3% of full scale
Resistance (4 ranges)	0-2kΩ (20Ω mid-scale) 0-20kΩ (200Ω mid-scale) 0-2MΩ (20kΩ mid-scale) 0-20MΩ (200kΩ mid-scale)	±3% of scale length
Current across Terminals at Resistance Range (LI) (4 ranges)	0-150mA (x1 range) 0-15mA (x10 range) 0-150μA (x1k range)	±5% of scale length (Battery voltage at 3V)
	0-60μA (x10k range)	
Voltage across Terminals at Resistance Ranges (LV) (4 ranges)	0-3V (x1, x10, x1 k ranges)	±5% of scale length (Battery voltage at 3V)
	0-12V (x10k)	(Battery voltage at 12 V)

Low Frequency Output Using OUTPUT Terminal	0-10V 0-50V 0-250V 0-1000V	Refer to frequency characteristic chart
Low Frequency Output (dB) (4 ranges)	10V AC -10 - +22dB 50V AC +4 - +36dB 250V AC +18 - +50dB 1000V AC +30 - +62dB (0 dB = 0.775V(1mW) across a 600Ω line)	Refer to frequency characteristic chart
DC Current Amplification Factor (h_{FE}) (1 range)	h_{FE} : 0-1000 (at $\Omega \times 10$ range)	$\pm 3\%$ of scale length

Dimensions: 100 (W) x 150 (L) x 47 (D)mm

Weight: Approx. 330g

Accessories: Test Leads (Model 7066A) - 1 set
F250V 0.5A fuse - 2 pcs. (including one spare fuse also installed into the housing case)
1.5V Battery Type R-6P, SUM-3, AA or equivalent - 2 pcs.
(Installed into the instrument)
9V Battery Type 6F22, 006P PP3, or equivalent - 1 pce (installed into the instrument)
Instruction Manual - 1 copy

4. Instrument Layout

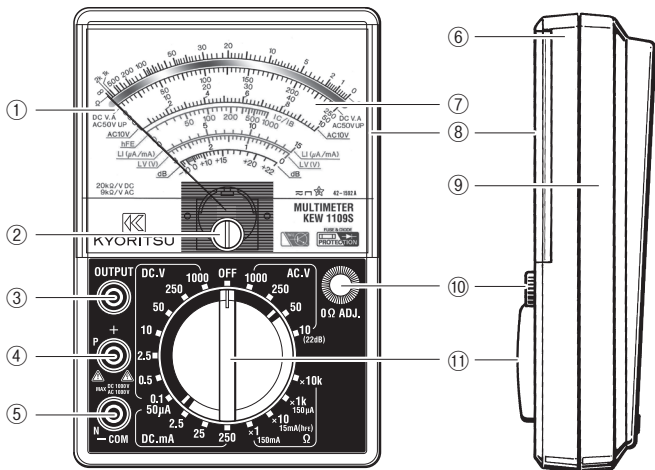

- | | |
|-------------------------|---------------------------|
| ① Meter Pointer | ② Meter Zero Adjust Screw |
| ③ OUTPUT Terminal | ④ +(P) Terminal |
| ⑤ -COM (N) Terminal | ⑥ Front Panel |
| ⑦ Mirrored Scale Plate | ⑧ Meter Window |
| ⑨ Housing Case | ⑩ Ohm Zero Adjust Knob |
| ⑪ Range Selector Switch | |

5. How to Read Scales

	Measuring Ranges	Scales	How to Read Scales	input Terminals
DC Voltage (7 ranges)	0.1V 0.5V 2.5V 10V 50V 250V 1000V	B 10 B50 B 250 B 10 B50 B250 B10	X0.01 X0.01 X0.01 X1 X1 X1 X100	+&-COM
AC Voltage (4 ranges)	10V 50V 250V 1000V	C10 B50 B250 B10	X1 X1 X1 X100	+&-COM
DC Current (4 ranges)	50 μ A 2.5mA 25mA 250mA	B50 B250 B250 B250	X 1 X0.01 X0.1 X1	+&-COM
Resistance (4 ranges)	X1 Ω x10 Ω x1k Ω X10k Ω	A 0-2k A0-2k A0-2k A0-2k	X1 X10 X1k X10k	+&-COM
Current across Terminals (LI)(4 ranges)	X1 Ω X10 Ω X1k Ω X10k Ω	E15 E15 E15 E15	X10(mA) X1(mA) X 10(μ A) X 4(μ A)	+&-COM
Voltage across Terminals (LV)(4 ranges)	x1 Ω X10 Ω X1k Ω X10k Ω	F3 F3 F3 F3	X1(V) X1(V) X1(V) X4(V)	+&-COM

Low Frequency Output Using OUTPUT Terminal (4 ranges)	10V 50V 250V 1000V	C10 B 50 B 250 B10	X1 X1 X1 X 100	Output & -COM
Low Frequency Output (dB) (4 ranges)	10V 50V 250V 1000V	G -10-+22dB G -10-+22dB G -10-+22dB G -10-+22dB	X1 X1 + 14dB X1 + 28dB X1 + 40dB	+ & -COM or Output & -COM
DC Current Amplification Factor (h_{FE}) (4 ranges)	X10 Ω	D 0-1000	X1	+&-COM

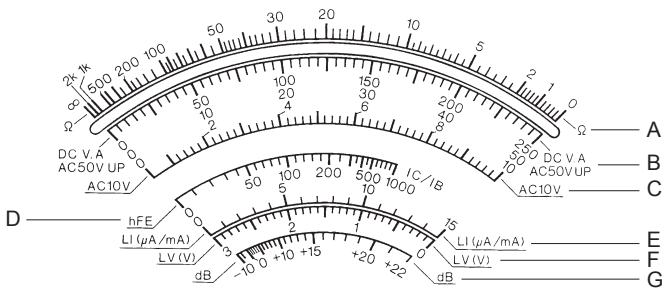

6. Operating Instructions

6-1. Preparation

- Make certain that the batteries are installed into the battery case with polarity in correct position. Also, make sure that the fuses are properly installed.
- The test leads are safety designed, but make sure that they are securely connected to the instrument before use.
- Check that the meter pointer lines up with the "0" mark on the left end of the scale. If it is off zero, rotate the zero adjust screw to bring the pointer to the zero position. Accurate measurements cannot be made without the zero adjustment.
- With the range selector switch at the $\times 1\Omega$ range position and the test leads connected to the + and -COM terminals of the instrument, short the test leads together. If the pointer does not deflect at all, the probable cause is the absence of batteries or the blown fuse. [Refer to section 7]
- With the range selector switch set to the $\times 1\Omega$ range position, short the tips of the test leads together. Turn the ohm zero adjust knob and make certain that the meter pointer moves to the "0" mark on the right end of the ohm scale. If not, the battery voltage is insufficient. Replace all of the 1.5V batteries (R6P, SUM-3 or equivalent). Refer to section 7 for battery replacement.
- With the range selector switch at the $\times 10k\Omega$ position short the tips of the test leads together. Then, turn the zero adjust knob clock-wise and make certain that the meter pointer moves to the "0" mark on the right end of the ohm scale. If not, the battery voltage is insufficient. Replace the 9V battery (6F22, 006P or equivalent).
- Select a measuring range suitable for the circuit being tested. When in doubt as to the maximum voltage or current expected, make sure to start with the highest voltage or current range of the instrument.

6-2. DC Voltage Measurements

⚠ WARNING

When measuring a high voltage greater than 250V, turn off power to the circuit under test and follow the steps as described below. Then, turn on power to the circuit being measured and proceed with the voltage measurements. Be careful not to touch the wiring, test leads and the instrument during voltage measurements. After making measurements, turn off power to the circuit under test and disconnect the test leads.

⚠ WARNING

Never use the instrument on a high voltage power line carrying more than 250V.

⚠ WARNING

Never make voltage measurements with the range selector switch set to the DC mA or ohm range position or the test lead erroneously connected to the AC 15A terminal. This may not only damage the instrument or blow the fuse, but also cause an injury to the operator.

Applications:

Measuring voltage on batteries, electrical appliances, bias voltage of IC of transistor circuits and any other DC voltages.

- (1) Insert the red test lead into the + terminal of the instrument and the black test lead into the –COM Terminal.
- (2) Set the range selector switch to the desired DC voltage range position. .
- (3) Connect the red test lead to the positive (+) side of the circuit under test and the black test lead to the negative (-) side of the circuit (in parallel with the circuit).
- (4) If the measured voltage is less than 250V, set the range selector switch to the lower voltage range position for more accurate reading.

6-3. AC Voltage Measurements

⚠ WARNING

When measuring a high voltage greater than 250V, turn off power to the circuit under test and follow the steps (1) to (3) as outlined below. Then, turn off power to the circuit under test and proceed with the voltage measurements. Never touch the wiring, test leads and instrument during measurements. After the voltage measurements, make sure to turn off power to the circuit under test and disconnect the test leads.

⚠ WARNING

Never use the instrument on a high voltage power line carrying more than 250V.

⚠ WARNING

Never make voltage measurements with the range selector switch set to the DC mA or ohm range position. This may not only damage the instrument or blow the fuse, but also cause an injury to the operator.

Applications:

Measuring voltage on household and factory electrical installations especially those for lighting, commercial power lines, power supply circuits, taps of transformers, etc.

- (1) Insert the red test lead into the positive (+) terminal of the instrument and the black test lead into the negative (-) COM terminal.
- (2) Set the range selector switch to the desired AC voltage range position.
- (3) Connect the test leads in parallel with the circuit under test (polarity of the circuit under test may be disregarded for AC voltage measurements).
- (4) As described in section 6-2-(4) for DC voltage measurements, select the desired AC voltage range switch position.

6-4. Low Frequency Output (dB) Measurements

Applications:

Measuring the ratio of output to input for amplifiers, transmission circuits, etc.

The ratio of output to input in amplifier and transmission circuits is expressed in logarithmic values as the human sense of hearing responds to the level of sound logarithmically. This is measured in terms of decibels (dB). Where the load impedance of a circuit is constant two values of power can be compared simply by indicating input to output voltage (current) ratio in dB.

The dB readings on the scale are references to 0 (zero) dB power level of 0.001 watt (one milliwatt) across 600 ohms, or 0.775V AC across 600 ohms. therefore, output in a 600 ohms impedance circuit can be read directly from the dB scale. When the impedance of a measuring circuit is not 600 ohms, however, a dB reading obtained is simply the result of measuring an AC voltage on the corresponding dB scale.

- (1) To measure decibels, read the dB scales in accordance with the instructions for AC voltage measurements.
- (2) For the 10V AC range read the dB scale directly (0 dB=1mW or 0.775V across 600 ohms). For other ranges including the 50V range read the dB scale and add the appropriate number of the dB to the reading as shown on Table 2.

Table 1

AC Volt Ranges	10V	50V	250V	1000V
Add dB	0	+14dB	+28dB	+40dB
Max. dB	+22dB	+36dB	+50dB	+62dB

6-5. Low Frequency Output Measurements Using Output Terminal

⚠ WARNING

When measuring a high voltage greater than 250V, turn off power to the circuit under test once and then follow the steps (1) to (3) as described for AC voltage measurements. Then, turn on power to the circuit and proceed with Low Frequency Output measurements.

Never touch the wiring, test leads or the instrument during measurements. After taking measurements, turn off power to the circuit under test and disconnect the test leads.

⚠ WARNING

Never make Low Frequency Output measurements with the range selector switch set to the DC mA or ohm range position. This may result in instrument damage, fuse blow or a possible injury to the operator.

Note: The blocking capacitor connected in series with the OUTPUT terminal may change the AC voltage response at low frequencies. The lower the Low Frequency Output the more apparent the change. The AC voltage response also changes at higher frequencies due to the frequency characteristics.

Use Table 2 for frequency characteristics to correct the Low Frequency Output reading.

Applications:

Measuring output voltage of low frequency amplifiers.

Detecting horizontal signals in horizontal amplification circuits of TV sets.

Detecting the presence of input signals in synchronous isolation and amplification circuits of TV sets.

The 1109S has a capacitor in series with the OUTPUT terminal. This OUTPUT terminal is useful for measuring the AC component only of a DC coupled Low Frequency Output in TV sets, audio equipment circuits, etc. by blocking the DC component.

- (1) Insert the red test lead into the OUTPUT terminal and the black test lead into the -COM terminal.
- (2) Make Low Frequency Output measurements in accordance with the instructions given for AC voltage measurements.

Table 2 Frequency Characteristics

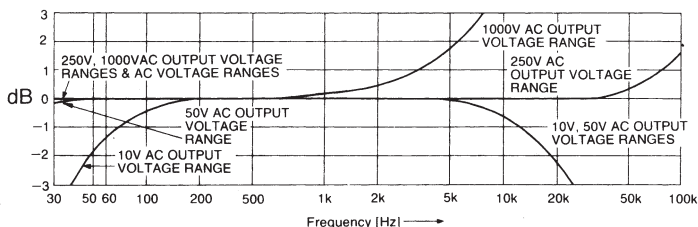

6-6. DC Current Measurements

⚠ WARNING

Make sure that the test leads are securely connected to the circuit. If the test prods are disconnected inadvertently, a high voltage may develop in the circuit.

⚠ WARNING

Never apply voltage to the current ranges. The fuse could blow or the instrument get damaged.

Especially when a voltage higher than 250V is applied accidentally, the fuse may not protect the circuit.

Applications:

Measuring currents in DC operated electrical appliances, bias current of transistors, IC's, etc.

- (1) Insert the red test lead into the + terminal and the black test lead into the -COM terminal.
- (2) Set the range selector switch to the 250mA range position.
- (3) Turn off power to the circuit under test.
- (4) Connect the red test lead in series with the positive (+) side of the circuit under test and the black test lead with the negative (-) side.
- (5) Turn on power to the circuit under test.
- (6) When the reading is below 25mA, set the range selector switch to the lower range for more accurate reading and proceed with the measurement.

6-7. Resistance Measurements

⚠ WARNING

Be sure to turn off power to the circuit under test before making resistance measurements.

⚠ WARNING

Never apply voltage to the ohm ranges. The fuse could blow or the instrument get damaged. Especially when a voltage higher than 250V is applied, the fuse may not protect the circuit.

⚠ CAUTION

A maximum voltage of 12V is present on the $\times 10k\Omega$ range. It may damage IC's for low voltage equipment.

Before making resistance measurements, carefully check the withstand voltage of the circuit under test.

⚠ CAUTION

Make the zero ohm adjustment after every change of the measuring range to obtain a more accurate reading.

Application:

Checking a resistance value of resistors, circuit continuity, short and open circuits, etc.

- (1) Insert the red test lead into the +terminal and the black test lead into the -COM terminal.
- (2) Set the range selector switch to the desired range position.
- (3) With the test lead tips shorted together turn the zero ohm adjust knob so that the meter pointer lines up with the zero mark at the right end of the ohm scale.
- (4) Turn off power to the circuit under test.
- (5) Connect the test leads to both ends of the circuit under test and take the reading (Fig. 2).

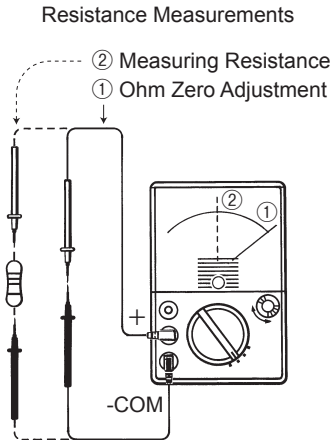

Fig. 2

Notes: Fig. 3 shows the resistance measuring circuit. The positive (+) polarity of the battery is connected to the positive (+) terminal of meter. Therefore, the polarity of the terminals is reversed for resistance measurements, with output voltage from the -COM terminal being positive (+) and output voltage from the +terminal negative (-). (Fig. 3).

A good knowledge of this relationship will be helpful in testing semi-conductors such as transistors and diodes as well as electrolytic capacitors.

Polarity of Multimeter Terminals at Resistance Measurements

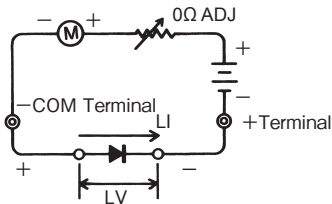

Fig. 3

6-8. Terminal Current LI, Terminal Voltage LV & Diode Test

⚠ CAUTION

Do not measure the internal resistance of a diode with low reverse withstand voltage using x 10k Ω range. The 12V voltage to be applied at this test could damage the diode. Check the rating of a diode before testing.

- (1) Current flowing across the $-$ COM terminal and + terminal during resistance measurements is indicated as LI. When LI flows into the circuit under test there occurs a voltage drop. This is defined as LV. Use the scale marked LI and LV for reading terminal current and voltage. Circuit impedance may change according to the current that flows into the circuit being measured or the voltage applied to the circuit. Also, an abnormal condition may develop in the circuit due to its self heating. Therefore, make resistance measurements at each range with the above in full consideration

Shown below are the values of terminal current and voltage on each resistance range: Table 3

Resistance Range	X1	X10	X1k	X10k
Multiply by	10	Direct Reading	10	4
Max. Terminal Current LI	150mA	15mA	150 μ A	60 μ A
Max. Terminal Voltage LV	3V	3V	3V	12V

- (2) If the connection to the circuit is made as shown in Fig. 4, it is possible to measure the forward current I_F or reverse current I_R of a diode using the LI scale. It is also possible to measure the forward voltage V_F or backward voltage V_A of a diode using the LV scale (Fig. 4).
- (3) As described for the resistance measurements, make the ohm zero adjustment after every change of the measuring range.

- (4) The meter pointer deflects close to full scale when the forward current I_F is measured. However, it hardly deflects when the reverse current I_R is measured.

The forward voltage of the average germanium diode measures 0.1 V to 0.2V and that of the silicon diode 0.5V to 0.8V.

- (5) Since the maximum open circuit voltage at the low resistance ranges is 3V (12V at X 10k range), it is possible to light up an LED having a forward voltage of more than 1.5V and measure forward current I_F as well. The reading on the LI scale indicates the forward current I_F at which the LED lights up. The reading on the LV scale also indicates the forward voltage V_F

For testing a large LED use the X1 Ω range. For a smaller LED having less than 10mA I_F use the X10 Ω range.

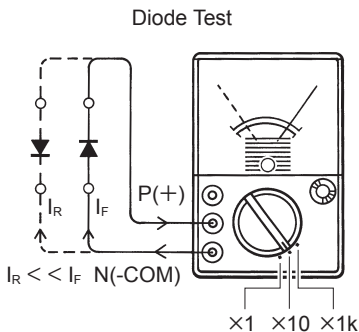

Fig.4

6-9. Measuring I_{CEO} (leakage current of transistors)

⚠ CAUTION

The leakage current does not change significantly according to voltage, but it rather exhibits constant current characteristics. However, note that the leakage current is very sensitive to the temperature and varies with the temperature change (approximately twice as against 10°C temperature rise)

⚠ CAUTION

When measuring I_{CEO} , do not touch the base of a transistor. Base current will flow and I_{CEO} increase.

⚠ CAUTION

If tested on the x10kΩ range, a transistor having V_{CE} less than 12V could possibly be damaged. Always check the rating of a transistor before testing.

- (1) Use the resistance measuring ranges to test transistors.
- (2) Insert the red and black test leads into the P(+) and N(-COM) terminals respectively.
- (3) With the tips of the test leads shorted together, turn the ohm zero adjust knob so that the meter pointer lines up with the "0" mark on the right end of the ohm scale.
- (4) Connect the test leads to the transistors according to their polarity, as shown in Fig. 5 (A) for the NPN transistor and Fig. 5 (B) for the PNP transistor.
- (5) Fig. 5 may be represented by an electrical circuit (Fig. 6).
(Part of the circuit located on the right side of the P/N terminals corresponds to be internal circuit of the multimeter.)
- (6) Current flowing between the P and N terminal is a reverse leakage current I_{CEO} . Take the reading on the LI scale.

Measuring Leakage Current of Transistor I_{CEO}

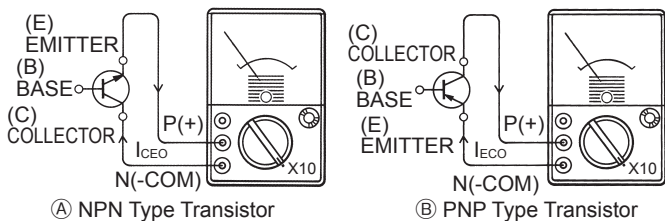

Fig. 5

- (7) The leakage current of the silicon transistor is too small to give pointer deflection. If the pointer should deflect, the likely cause would be some fault of the silicon transistor.

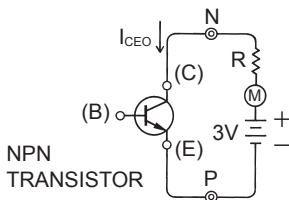

Fig. 6

- (8) With the germanium transistor the leakage current flows even if it is good, but the amount slightly differs with the types of the transistor. Use Table 4 below to determine if the germanium transistors are good or bad.

Small & Medium Sized Transistors	Large Sized Transistors
Approx. 0.1 - 2mA	Approx. 1 - 5mA

If the leakage current exceeds the above values appreciably, the transistors are faulty.

6-10. Measuring h_{FE} (DC Current Amplification Factor)

⚠ CAUTION:

With the germanium transistor, the leakage current flows into the collector side, causing that much error in leakage current measurements. Therefore, obtain a true value of leakage current by deducting a h_{FE} value equivalent to the leakage current from the measured value.

(1) The following will explain about the principle of h_{FE} measurements.

As shown in Fig. 7, the collector and emitter of a transistor are connected to the multimeter. When a resistor R of a certain resistance value (approx. $24k\Omega$) is connected across the N (-COM) terminal of the instrument and the base of the transistor, base-terminal current I_B , determined by R (approx. $24k\Omega$), flows and current I_C , multiplied by h_{FE} , also flows into the collector of the transistor, resulting in the increase of DC current and thus causing the meter indication to change notably.

Theoretically, the h_{FE} ($=I_C/I_B$) of a transistor (DC current amplification factor) can be measured by plotting the amount of the current change on a separate h_{FE} scale.

The h_{FE} scale for KEW1109S is marked for the $24k\Omega$ R (approx. $100\mu A$ base current at $3V$ LV).

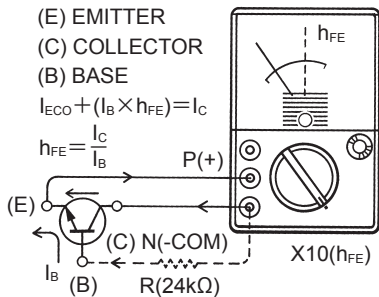

Fig. 7

(2) How to Use h_{FE} Test Leads

The test lead set mainly consisting of a resistor and a clip as shown in Fig. 8 is on the market and is recommended for use in making h_{FE} measurements.

Test Lead Set for h_{FE} Measurements

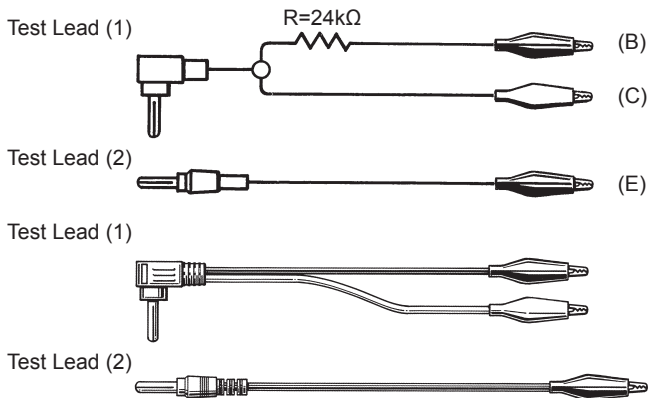

Fig. 8

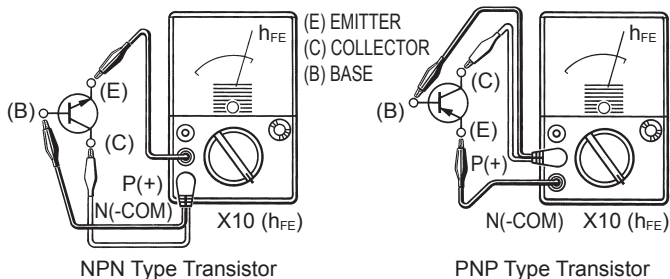

Fig. 9

As indicated in Fig. 9, connect the h_{FE} test lead (1) to the multimeter, according to the polarity of a transistor to be tested; N (-COM) terminal for the NPN type transistor or P (+) terminal for the PNP type transistor.

Also, connect the h_{FE} test lead (2) to the P(+) terminal for the NPN type transistor and the N (-COM) terminal for the PNP type transistor. With the test lead clips (E) and (C) shorted, turn the ohm zero adjust knob so that the pointer lines up with the zero (0) mark on the right end of the ohm scale. Then, connect the h_{FE} test lead clips as follows:

Clip (C) and clip (B) for h_{FE} test lead (1) to the collector and base terminals of the transistor respectively.

Clip (E) of the h_{FE} test lead (2) to the emitter of the transistor.

(3) When the transistor is good, the indicated value is small, representing leakage current I_{CEO} only with the base terminal open ($I_B=0$).

If base-terminal DC current I_B flows, collector-terminal DC current I_C changes and meter gives a reading of the current increased by $I_B \times h_{FE}$.

(4) When the transistor is faulty, the three possible cases may be considered.

There is no change in the current reading between the times when the base terminal is open ($I_B=0$) and when I_B flows.

No meter pointer deflection even when I_B flows.

The meter pointer moves past the h_{FE} scale and deflects close to full scale, even when the base terminal is open ($I_B=0$).

7. Fuse & Battery Replacement

⚠ WARNING

Never replace the fuse or batteries during measurements. Make sure to set the range selector switch to OFF position and remove the test leads from the instrument before replacing the fuse and batteries.

Always use the F 2S0V 0.5A fuse as specified.

- (1) When the fuse blows remove the housing case by unscrewing the case fixing screw to replace the fuse.
- (2) When 2 x 1.5V battery (R-6P, SUM-3 or equivalent) are exhausted, it is no longer possible to zero ohm adjust on the x 1 Ω range. Remove the housing case by unscrewing the case fixing screw to replace the batteries. Observe correct polarity when replacing the batteries.
- (3) When the 9V battery (6F22, 006P or equivalent) is exhausted, it is no longer possible to zero ohm adjust on the X10k Ω range. Remove the housing case by unscrewing the case fixing screw to replace the battery.

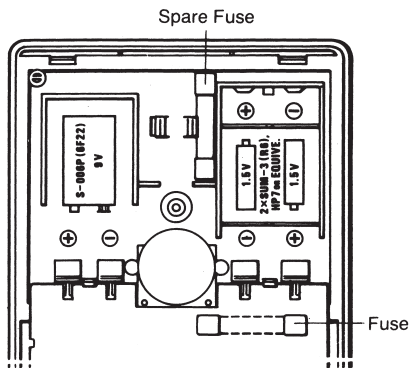

PCB Component Layout Drawing

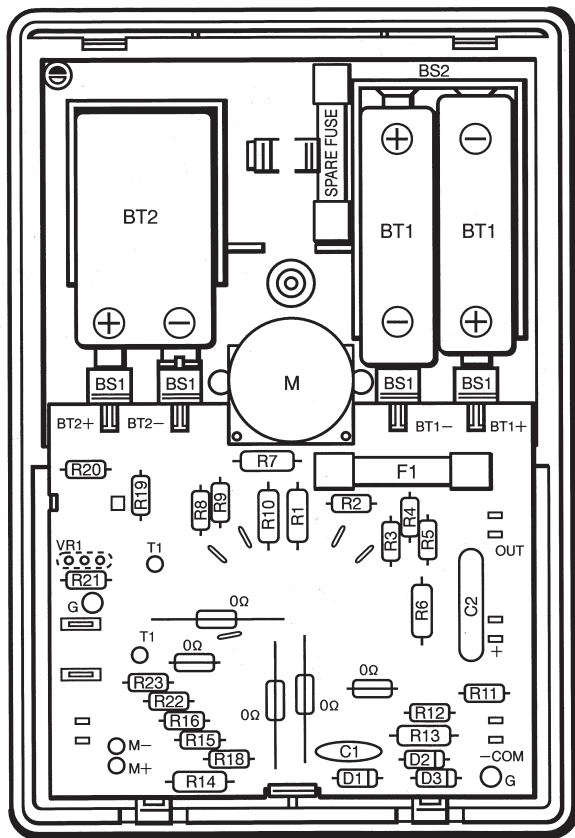
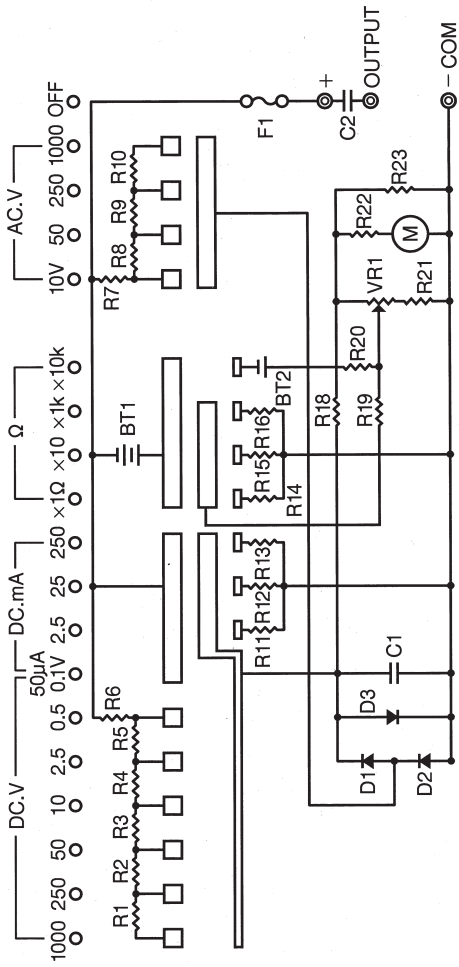

Fig. 11

PARTS LIST

No.	DESCRIPTION			
R1	Resistor	1/2WF,	(15M Ω)	DC 1000 V
R2	Resistor	1/4WF,	(4M Ω)	DC 250 V
R3	Resistor	1/4WF,	(800 K Ω)	DC 50 V
R4	Resistor	1/4WF,	(150 K Ω)	DC 10 V
R5	Resistor	1/4WF,	(40K Ω)	DC 2.5 V
R6	Resistor	1/2WF,	(8K Ω)	DC 0.5 V
R7	Resistor	1/2WF,	(83.3 K Ω)	AC 10 V
R8	Resistor	1/4WF,	(360 K Ω)	AC 50 V
R9	Resistor	1/4WF,	(1.8M Ω)	AC 250 V
R10	Resistor	1/2WF,	(6.75M Ω)	AC 1000 V
R11	Resistor	1/4WF,	(40.7 Ω)	DC 2.5m A
R12	Resistor	1/4WF,	(4 Ω)	DC 25m A
R13	Resistor	1/2WF,	(0.379 Ω)	DC 250m A
R14	Resistor	1/2WF,	(18 Ω)	Ω X 1
R15	Resistor	1/4WF,	(200 Ω)	Ω X 10
R16	Resistor	1/4WF,	(34K Ω)	Ω X 1K
R18	Resistor	1/4WF,	(240 Ω)	
R19	Resistor	1/4WF,	(44K Ω)	
R20	Resistor	1/4WF,	(195 K Ω)	Ω X10K
R21	Resistor	1/4WF,	(18K Ω)	
R22	Resistor	1/4WF,	(750 Ω)	
R23	Resistor	1/4WF,	(31K Ω)	
VR1	Variable Resistor,	(10K Ω)		
D1,2,3	Diode	1N4448		
C1	Ceramic Capacitor,	0.047 μ F50V		
C2	Metal Film Capacitor,	0.047 μ F630V(OUTPUT)		
BT1	Battery	1.5V,R6P,SUM-3 or equiv. (X2)		
BT2	Battery	9V, 6F22, 006P or equiv.		
F1	Fuse, Fast Acting Type,	F250V/0.5A, ϕ 6 \times 30mm		
M	Meter Movement,	(44 μ A / 1.25K Ω)		
BS1	Battery Contacts	(X4)		
BS2	Battery Contact	(X1)		



CIRCUIT DIAGRAM

MEMO

MEMO

DISTRIBUTOR

Kyoritsu reserves the rights to change specifications or designs described in this manual without notice and without obligations.



**KYORITSU ELECTRICAL
INSTRUMENTS
WORKS, LTD.**

2-5-20, Nakane, Meguro-ku,

Tokyo, 152-0031 Japan

Phone: +81-3-3723-0131

Fax: +81-3-3723-0152

URL: <http://www.kew-ltd.co.jp>

E-mail: info-eng@kew-ltd.co.jp

Factory: Ehime, Japan