

**Mitutoyo**

# **Linear Gage Counter EV Series**

**EV-16P**

**EV-16D**

**EV-16Z**

## **User's Manual - Instructions for use -**

Read this User's Manual thoroughly before operating the instrument.  
After reading, retain it close at hand for future reference.

No. 99MBC034B7

Date of publication: January 1, 2018



---

## ■ Product names and model numbers

- EV-16P
- EV-16D
- EV-16Z

## ■ Notice regarding this document





- Mitutoyo Corporation assumes no responsibilities for any damage to the instrument, caused by its use not conforming to the procedure described in this document.
- Upon loan or transfer of this instrument, be sure to attach this document to the product.
- In the event of loss or damage to this document, immediately contact a Mitutoyo sales office or your dealer.
- Before operation of the product, thoroughly read this document to comprehend its contents.
- Particularly, for full understanding of information, carefully read "Safety Precautions" "Precautions for Use" at the outset of this manual before using the product.
- The contents in this document are based on the information current as of January, 2018.
- No part or whole of this document may be transmitted or reproduced by any means without prior written permission of Mitutoyo Corporation.
- Some screen displays in this document may be highlighted, simplified or partially omitted for convenience of explanation. In addition, some of them may differ from actual ones to the extent that no user will misunderstand the functions and operations.
- The corporation, organization and product names that appear in this manual are their trademarks or registered trademarks.

© 2018 Mitutoyo Corporation. All rights reserved.



## CONVENTIONS USED IN THIS DOCUMENT

Conventions used in Mitutoyo's User's Manual are roughly divided into three types (safety reminders, prohibited actions and mandatory actions). Moreover, these safety symbols include general warnings and specific warnings. Specific warning symbols are provided with concrete pictograms inside of them.

### ■ Safety reminder conventions and wording warning against potential hazards

General	 <b>DANGER</b>	Indicates an immediately hazardous situation which, if not avoided, will result in serious injury or death.
	 <b>WARNING</b>	Indicates a potentially hazardous situation which, if not avoided, could result in serious injury or death.
	 <b>CAUTION</b>	Indicates a potentially hazardous situation which, if not avoided, may result in minor injury.
	<b>NOTICE</b>	Indicates a potentially hazardous situation which, if not avoided, may result in property damage.
Specific		Alerts the user to a specific hazardous situation that means "Caution, risk of electric shock".

### ■ Conventions and wording indicating prohibited actions and mandatory actions

General	 <b>Mandatory</b>	Indicates concrete information about mandatory actions.
Specific		Indicates that grounding needs to be implemented.

### ■ Conventions and wording indicating referential information or referential locations

**Tips** Indicates referential information such as that for when the operating methods and procedures which are printed in these sentences are to be applied to specific conditions.



Indicates referential locations if there is information that should be referred to in this document or an extraneous manual.

Example: For details about xxx, see  "1.3 Part Names and Functions" (page 3).

---

## Safety Precautions

Read these Safety Precautions thoroughly before operating the system to use it properly. These safety precautions include such information as to prevent an injury to the operator and other persons or damage to property. Be sure to observe the precautions.



Do not remove the cover or disassemble the product. Otherwise you may be subject to electric shock, and there is a risk of breakage or fire due to a short circuit caused by metallic powders that have gotten inside the product.

## Precautions for Use

### ■ Product applications and handling

#### ● This product is a Counter.

Do not use this product for any purposes other than as a Counter.

#### ● This is an industrial product.

Do not use this product for any purposes other than industrial applications.

#### ● This product is precision equipment.

Handle this product with care. Be careful not to apply excessive shock or force to any of the parts during operation.

### ■ Installation environment

This product is designed for indoor use. To ensure optimal performance for this precision equipment, take the following conditions into account when installing this product.

- **Vibration**

Install this product in an environment where it will be subject to minimal vibration. Using this product in a place with significant vibration for an extended period of time may result in malfunction of the precision components. If using this product in a place with significant vibration is unavoidable, lay a vibration-proof rubber sheet, etc., under this product in order to reduce the vibration.

- **Dust**

Dust in the installation site negatively affects the electrical components in the Display. Install this product in an environment where it will be subject to minimal dust.

- **Sunlight**

If this product is exposed to direct sunlight, the heat will cause deformations in the main body, negatively affecting its operation. If installing this product in an environment that is exposed to direct sunlight, such as near a window, is unavoidable, protect it from the sunlight by curtaining it off, etc.

- **Ambient temperature, humidity**

Use this product in a place where the ambient temperature is within the range of 0 °C to 40 °C. Avoid using it in a place that is subject to sudden changes in temperature or humidity.

---

Take special shielding measures when using this product in the following locations:

- In locations subject to electric noise, such as from static electricity
- In locations subject to strong electric fields
- In locations near power supply lines/power lines
- In locations where it may directly exposed to chips, cutting fluids, water, etc.
- In locations that may be exposed to radiation
- In locations that may be exposed to corrosive gases

## ■ Maintenance

Gently wipe dirt off of the product with a soft, tightly woven cloth. If dirt is difficult to remove, wipe the dirt off with a cloth soaked in a neutral detergent, and then gently wipe the product with a dry cloth or a cloth that is tightly wrung after being soaked in water. Do not use organic solvents such as thinner or benzene.

## ■ Power supply

- Turn off the power switch after use.
- Use only a DC power source for this product that is rated at 12 V to 24 V and an output current of 1 A or more. Never use this power source with other electric equipment that runs at a high voltage and/or large current.
- Do not connect the AC adapter to a high-current power used by machine tools or large CNC measuring instrument.

---

## Electromagnetic Compatibility (EMC)

This product complies with the EU EMC Directive. Note that in environments where electromagnetic interference exceeds the EMC requirements defined in this directive, appropriate countermeasures are required to assure product performance.

## Export Control Compliance

This product falls into the Catch-All-Controlled Goods and/or Catch-All-Controlled Technologies (including Programs) under Category 16 of Appended Table 1 of the Export Trade Control Order or under Category 16 of the Appended Table of Foreign Exchange Control Order, based on the Foreign Exchange and Foreign Trade Act of Japan.

If you intend re-exporting the product from a country other than Japan, re-selling the product in a country other than Japan, or re-providing the technology (including program), you shall observe the regulations of your country. Also, if an option is added or modified to add a function to this product, this product may fall under the category of List-Control Goods and/or List-Control Technology (including Programs) under Category 1 - 15 of Appended Table 1 of the Export Trade Control Order or under Category 1 - 15 of the Appended Table of Foreign Exchange Control Order, based on Foreign Exchange and Foreign Trade Act of Japan. In that case, if you intend re-export of the product from a country other than Japan, re-sale of the product in a country other than Japan, or re-provision of the technology (including program), you are obligated to observe the regulations of your country. Please contact Mitutoyo in advance.

## Notes on Export to EU Member Countries

When you intend exporting this product to any of the EU member countries, it may be required to provide User's Manual(s) in English and EU Declaration of Conformity in English (under certain circumstances, User's Manual(s) in the destination country's official language and EU Declaration of Conformity in the destination country's official language). For detailed information, please contact Mitutoyo in advance.

## Disposal of Old Electrical & Electronic Equipment (Applicable in the European Union and other European countries with separate collection systems)



This symbol on the product or on its packaging is based on the WEEE Directive (Directive on Waste Electrical and Electronic Equipment), which is a regulation in EU member countries, and indicates that this product shall not be treated as household waste.

To reduce environmental impact and minimize the volume of landfill, please cooperate in reuse and recycling. For information on how to dispose of the product, please contact your dealer or the nearest Mitutoyo sales office.

---

## Warranty

In the event that this product should prove defective in workmanship or material, within one year from the date of original purchase for use, it will be repaired or replaced free of charge. Please contact your dealer or the nearest Mitutoyo sales office.

If this product fails or is damaged for any of the following reasons, it will be subject to a repair charge even if it is still under warranty.

- Failure or damage owing to fair wear and tear
- Failure or damage owing to inappropriate handling, maintenance, or repair, or to unauthorized modification
- Failure or damage owing to transport, dropping, or relocation of the product after purchase
- Failure or damage owing to fire, salt, gas, abnormal voltage, lightning surge, or natural disaster
- Failure or damage owing to use in combination with hardware or software other than that designated or permitted by Mitutoyo
- Failure or damage owing to use in ultra-hazardous activities

This warranty is effective only where the instrument is properly installed and operated in conformance with the instructions in this document within the original country of the installation.

EXCEPT AS SPECIFIED IN THIS WARRANTY, ALL EXPRESS OR IMPLIED CONDITIONS, REPRESENTATIONS, AND WARRANTIES OF ANY NATURE WHATSOEVER INCLUDING, WITHOUT LIMITATION, ANY IMPLIED WARRANTY OF MERCHANTABILITY, FITNESS FOR A PARTICULAR PURPOSE, NONINFRINGEMENT OR WARRANTY ARISING FROM A COURSE OF DEALING, USAGE, OR TRADE PRACTICE, ARE HEREBY EXCLUDED TO THE MAXIMUM EXTENT ALLOWED BY APPLICABLE LAW.

You assume all responsibility for all results arising out of the selection of this product to achieve your intended results.

---

## Disclaimer

IN NO EVENT WILL MITUTOYO, ITS AFFILIATED AND RELATED COMPANIES AND SUPPLIERS BE LIABLE FOR ANY LOST REVENUE, PROFIT, OR DATA, OR FOR SPECIAL, DIRECT, INDIRECT, CONSEQUENTIAL, INCIDENTAL, OR PUNITIVE DAMAGES, HOWEVER CAUSED, AND REGARDLESS OF THE THEORY OF LIABILITY ARISING OUT OF THE USE OF, OR INABILITY TO USE THIS PRODUCT, EVEN IF MITUTOYO OR ITS AFFILIATED AND RELATED COMPANIES AND/OR SUPPLIERS HAVE BEEN ADVISED OF THE POSSIBILITY OF SUCH DAMAGES.

If, notwithstanding the foregoing, Mitutoyo is found to be liable to you for any damage or loss which arises out of, or is in any way connected with use of this product by you, in no event shall Mitutoyo's and/or its affiliated and related companies' and suppliers' liability to you, whether in contract, tort (including negligence), or otherwise, exceed the price paid by you for the product only.

BECAUSE SOME COUNTRIES, STATES OR JURISDICTIONS DO NOT ALLOW THE EXCLUSION OR THE LIMITATION OF LIABILITY FOR CONSEQUENTIAL OR INCIDENTAL DAMAGES, IN SUCH COUNTRIES, STATES OR JURISDICTIONS, MITUTOYO'S LIABILITY SHALL BE LIMITED TO THE EXTENT PERMITTED BY LAW.



---

## About This Document

### ■ Positioning of this document in document map

In addition to this document, a User's Manual for SENSORPAK that is installed and used on a PC, and a User's Manual for each Linear Gage that is connected to and used with this product are available.

### ● Manuals for Counters

EV Counter  
User's Manual (this document)

D-EV External Display Unit  
User's Manual

SENSORPAK  
User's Manual

### ● Manuals for Linear Gages

LGK  
User's Manual

LGF (Standard)  
User's Manual

LGF (Origin mark)  
User's Manual

LGB  
User's Manual

LGD  
User's Manual

LG-1100  
User's Manual

LGM  
User's Manual

LGS  
User's Manual

---

## ■ Intended readers and purpose of this document

### ● Intended readers

This manual is intended for beginners of the EV-series counters.

Readers are assumed to be familiar with the basic operations of a PC and Windows. They are also assumed to be able to understand instructions by reading technical drawings.

### ● Purpose

To use this product safely and correctly, read this document thoroughly. After reading, keep it in a safe place close to the product.

The purpose of this document is to help you understand how to use EV-series counters.

## ■ How to read this document

### ● When you do not know the appropriate operation while using this product

Look for the page with the desired operation in "Contents".

### ● To measure

The setup of this product and the settings of parameters are required in advance.

See the following pages for basic measurements, such as height measurement.

☰ "1 Overview" (page 1) to ☰ "3.3 Basic Parameters" (page 17)

In addition to the pages above, see the following pages for applied measurements, or for external equipment connection. ☰ "3.4 Advanced Parameters" (page 19)

### ● Terms and definitions

- INPUT: Linear Gages connected to the Linear Gage input connectors
- Internal counter (CEL): The six internal counters (CEL1 to CEL6)

**Tips** For details about CEL, see ☰ "3.2.1 Internal Structure of the Counter" (page 16).

---

**MEMO**

---

# Contents

<b>1 Overview</b> .....	<b>1</b>	<b>5 External Input/Output Function</b> .....	<b>40</b>
1.1 Major Functions .....	1	5.1 RS-232C Communication Function .....	40
1.2 Supported Equipment .....	2	5.2 RS LINK Function .....	45
1.3 Part Names and Functions .....	3	5.3 I/O Connector Terminal Function .....	47
1.4 Operation Flow .....	6		
<b>2 Setup</b> .....	<b>7</b>	<b>6 Parameter Setting Method (Setting with the EV Counter Main Body)</b> .....	<b>67</b>
2.1 Unpacking .....	7	6.1 Parameter Mode ON .....	67
2.2 Mounting .....	7	6.2 Setting Parameters .....	68
2.3 Connections .....	8	6.3 Parameter Mode OFF .....	69
		6.4 List of Parameters .....	70
<b>3 Setting Parameters</b> .....	<b>12</b>	<b>7 Troubleshooting</b> .....	<b>74</b>
3.1 Parameter Setting Method .....	12	7.1 Troubleshooting .....	74
3.2 Overview of Setting Parameters .....	14	7.2 Error Messages .....	76
3.3 Basic Parameters .....	17		
3.4 Advanced Parameters .....	19		
3.5 Setting Example .....	22		
<b>4 Basic Operations</b> .....	<b>26</b>	<b>8 Specifications</b> .....	<b>79</b>
4.1 Precautions for Power-On .....	26	8.1 Basic Specifications .....	79
4.2 Display / Operation CEL Selection (When the D-EV Is Used) .....	26	8.2 External Dimensions Drawing (For All Models) .....	80
4.3 Input of Preset Value / Tolerance Value (When the D-EV Is Used) .....	28	8.3 Option .....	82
4.4 Preset (When the D-EV Is Used) .....	33		
4.5 Peak Mode Setting .....	35		
4.6 Tolerance Judgment (When the D-EV Is Used) .....	37		
4.7 Error Cancellation Method (When the D-EV Is Used) .....	39		

# 1 Overview

This section describes the features and part names of this product.

## 1.1 Major Functions

This product is a Counter that outputs the counter values from connected Mitutoyo Linear Gages. To display counter values, a D-EV External Display Unit (option) is required.

In addition, the following functions are available.

- Up to six Linear Gages can be connected to this product.
- It is recommended to use a D-EV External Display Unit (option).
- The device uses RS-232C and I/O connector as interfaces, and data can be output according to the application by combining three output modes and three output formats.
  - Interface
    - RS-232C : Interface conforming with EIA RS-232C
    - I/O connector : Interface for data output specified by output format and input of external operation signals
  - Output mode
    - Normal mode : Outputs the counter value from the connected gage to the specified CEL.
    - Calculation mode : Calculates the total, maximum, minimum, and width between specified CELs and outputs the result.
    - High-speed mode : Outputs data of the specified CEL at high speed.
  - Output format
    - Tolerance judgment output : Independently outputs the judgment result of each CEL.
    - Segment output : Outputs the range specified by the external signal by equally dividing it into  $\pm 10$  stages.  
Specifies output CELs and range with external SET signal.
    - BCD output : Sign + 6 digit data output  
Specifies output CELs with external SET signal.
    - RS-232C output : Up to 10 units / 60 CH connection possible  
Remote control of Preset / tolerance values possible  
Simultaneous use with other I/Os possible
- Has a counter connection (RS LINK) function, and it is possible to construct a system that outputs data of a maximum of 10 Counters (a maximum of 60 gages) from one RS-232C terminal to a PC, etc.

## 1.2 Supported Equipment

### ■ Supported Linear Gages

The following table shows the Linear Gages supported by this product and their features:

Sign	Supported Linear Gages	Feature
EV-16P	LGF, LGB, LGK, etc.	<ul style="list-style-type: none"> <li>Differential square-wave output type</li> <li>High resolution down to 0.1 <math>\mu\text{m}</math></li> <li>High-speed response of 1.5 m/s (LGF)</li> </ul>
EV-16D	LGD, LGS, etc.	<ul style="list-style-type: none"> <li>Digimatic output type</li> <li>ABS function (no need for master setting)</li> </ul>
EV-16Z	LGF-Z, etc.	<ul style="list-style-type: none"> <li>Scale reference-point signal output type (The origin can be restored even if the power switch is turned off.)</li> </ul>

### ■ Supported display equipment

The following table shows the display equipment supported by this product and their features:

Sign	Supported display equipment	Feature
EV-16P, EV-16P, EV-16Z	D-EV	<ul style="list-style-type: none"> <li>Displays the counter value of EV Counter.</li> <li>Simple settings of the Counter are possible.</li> <li>Error code display is possible.</li> </ul>

## 1.3 Part Names and Functions

### 1.3.1 Main Body

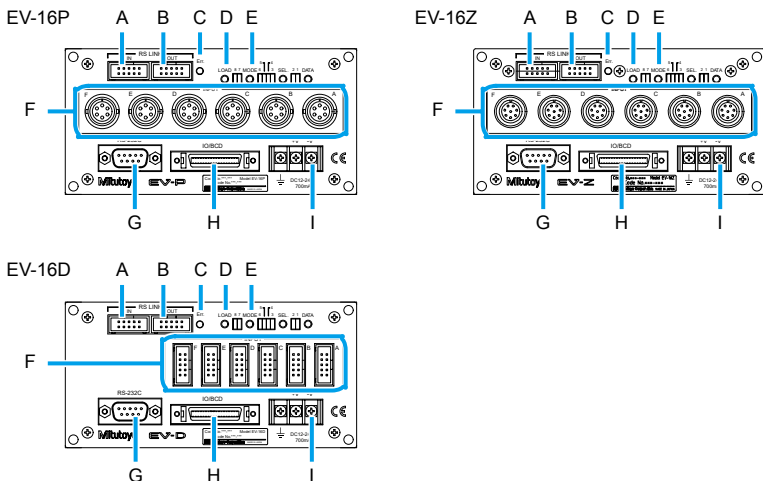

Symbol	Name	Description
A	RS_LINK connector (IN)	For connecting an RS LINK connection cable. Also used for the SENSORPAK license key.
B	RS_LINK connector (OUT)	For connecting an RS LINK connection cable. D-EV External Display Unit (option) is connected here.
C	Error LED	Lights when an error occurs.
D	Parameter input switch (four pieces)	Used to set the parameters on the EV Counter main body.
E	Parameter LED (eight pieces)	Lights when parameter settings are performed on the EV Counter main body.
F	Linear Gage input connector (from the right, A, B, C, D, E, F)	For connecting a Linear Gage. The connected Linear Gages are called INPUT A, INPUT B, INPUT C, INPUT D, INPUT E, and INPUT F in order from the right.
G	RS-232C connector	For connecting an RS-232C connecting cable.
H	I/O connector	For connecting an I/O connecting cable.
I	Power inlet terminal strip	For connecting the Terminal strip connecting cable or a DC power cable.

## 1.3.2 D-EV External Display Unit (Option)

The D-EV External Display Unit (option) is an optional product for displaying the measured values from the EV Counter and setting the measurement conditions (parameter settings).

One D-EV can display / set one EV Counter.

- D-EV external appearance drawing (front side)

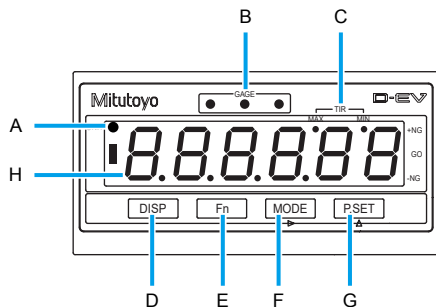

- D-EV external appearance drawing (rear side)

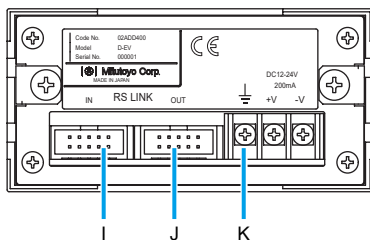

Symbol	Name	Description
A	UNIT indicator	<ul style="list-style-type: none"> <li>Blinks while a HOLD signal is being input when the I/O connector is connected.</li> <li>Lights when an E unit has been selected for the corresponding parameter.</li> </ul>
B	GAGE indicator	<ul style="list-style-type: none"> <li>Indicates the tolerance judgment result by color.</li> <li>Indicates the currently selected channel or cell.</li> <li>Indicates the type of the set value by color when Preset values or tolerance judgment values are being set.</li> </ul>



## 1 Overview

Symbol	Name	Description
C	Peak mode indicator	Indicates the Peak-mode type.
D	[DISP] key	Switches what is shown (measured value from the Linear Gage, tolerance value, tolerance judgment) on the Display. Measured value display: CH Tolerance value display: CE
E	[Fn] key	Switches to setup mode where you can set tolerance values or the Preset value.  <b>Tips</b> <ul style="list-style-type: none"><li>• When setting parameters, this advances the parameter number.</li><li>• When setting tolerance values or the Preset value, this cancels the setting.</li></ul>
F	[MODE] key	Sets Peak mode.  <b>Tips</b> When setting tolerance values or the Preset value, this moves the current input digit from left to right.
G	[P.SET] key	<ul style="list-style-type: none"><li>• Sets the Preset value set in advance.</li><li>• Cancels an error.</li></ul> <b>Tips</b> <ul style="list-style-type: none"><li>• When setting a parameter, this advances the set value.</li><li>• When setting tolerance values or the Preset value, this increases the value of the selected digit.</li></ul>
H	Display	Displays the counter value from the connected Linear Gage.
I	RS_LINK connector (IN)	For connecting an RS LINK connection cable. Connects to the EV Counter. Displays the data from the EV Counter connected to this connector.
J	RS_LINK connector (OUT)	For connecting an RS LINK connection cable.
K	Power inlet terminal strip	For connecting the Terminal strip connecting cable or a DC power cable.

## 1.4 Operation Flow

The basic operation flow is explained below. Do not omit the operations enclosed with a solid line. Perform the operations enclosed with a dashed line as necessary.

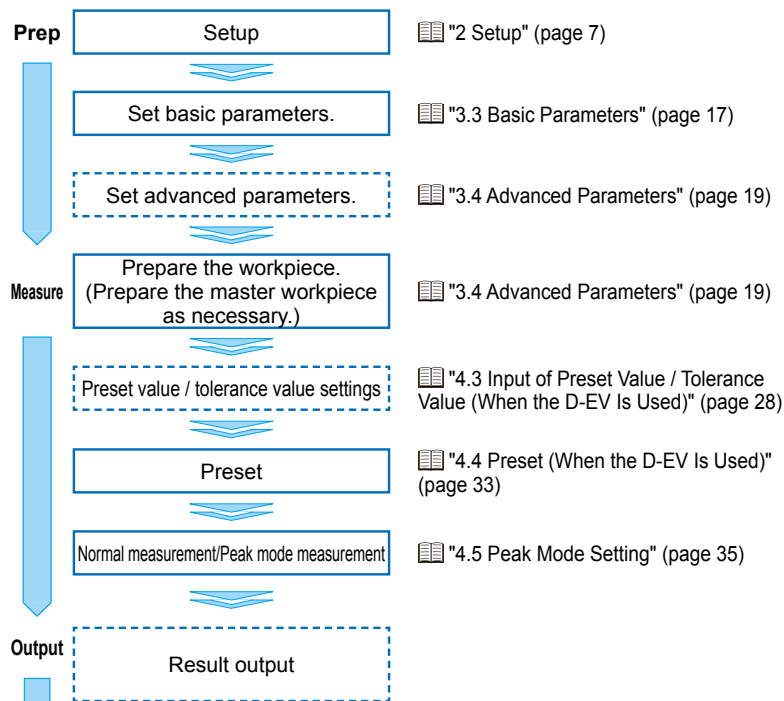

## 2 Setup

### 2.1 Unpacking

When unpacking for the first time, check that the following components are contained in the box.

Name	Q'ty	Name	Q'ty
Linear Gage Counter (this product)	1	Foot	4
Junction bracket	4	Mounting screw M4 × 12	8
User's Manual (this document)	1	Supplemental operation manual	1
Warranty	1	—	—

### 2.2 Mounting

#### 2.2.1 EV Counter Mounting

There are four mounting holes on each of the front panel and rear panel of the EV Counter. Please mount the EV Counter using standard accessory fixing legs and junction brackets.

##### ■ How to use fixing legs

- 1 Attach the fixing legs (four places) to the Counter main body with the supplied screws.
- 2 Secure the Counter to the device using the oblong hole of the fixing leg.

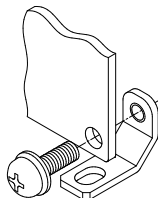
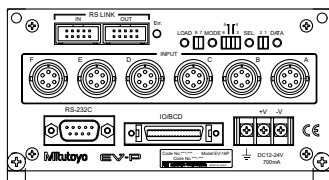

## 2 Setup

### ■ How to use junction brackets

- 1 Join the panels together using the supplied screws and junction brackets.

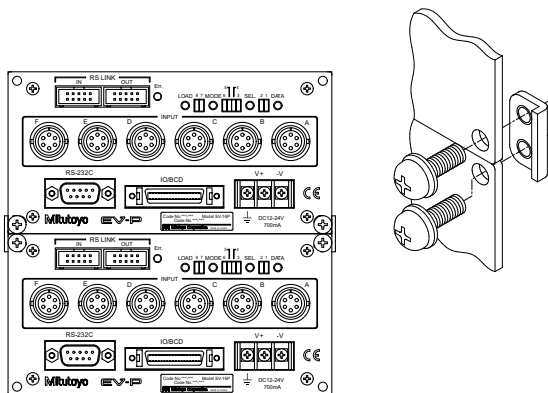

## 2.3 Connections

### 2.3.1 Power Supply

Prepare a DC power source (voltage: 12 V to 24 V, output current: 1 A or more) for each Counter. An AC adapter is available as an option. To use the AC adapter, connect an AC cable and the Terminal strip connecting cable to the AC adapter.

**NOTICE** Never use this power source with other electric equipment that runs at a high voltage and/or large current.

**Tips** If you use a commercial power source, use a power cable with a length of 30 m or shorter. Avoid outdoor wiring.

### 2.3.2 Connecting Cables for External Equipment

You must supply a RS-232C and an I/O connector connecting cable for connecting external equipment.

Use a Mitutoyo-approved connecting cable for RS LINK connections.

For details about RS-232C connecting cables, see [■ "5.1 RS-232C Communication Function"](#) (page 40).

For details about I/O connecting cables, see [■ "5.3 I/O Connector Terminal Function"](#) (page 47).

For details about RS LINK, see [■ "5.2 RS LINK Function"](#) (page 45).

### 2.3.3 Connection Procedure

#### NOTICE

- When making connections, connect the power cable last.
- Do not run the power cable and Linear Gage connecting cable through a cable duct together with other power lines.
- Secure the power cable and connecting cables for external equipment to your equipment with a cable tie, cable holder, etc.

#### Tips

Be sure to connect this product to ground. If this product is not grounded, it will be more susceptible to electrical noise.

Make connections as shown in the figure below.

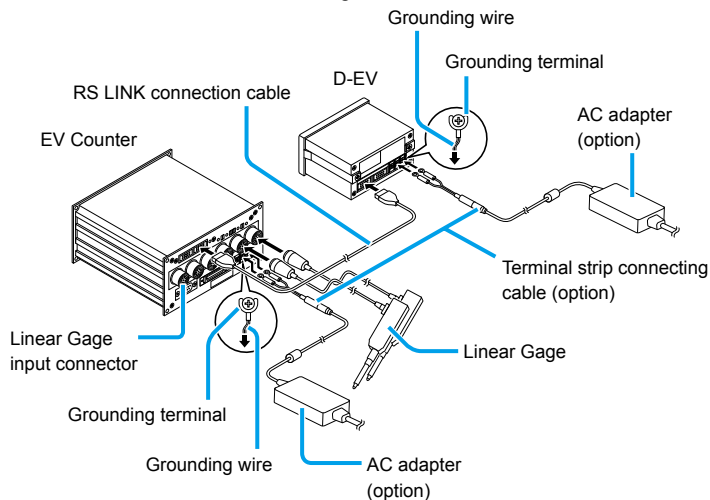

## 2 Setup

### 2.3.4 Confirm the Connection (When the D-EV Is Used)

Check the cable connections with the following procedure to confirm that the connections are correct.

#### 1 Connect to power.

- » The Counter enters the stand-by state.

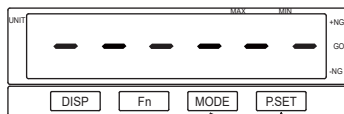

#### 2 Press [P.SET].

- » The Counter changes to the Counter display.



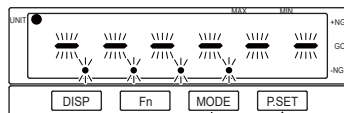

**Tips** EV-16Z will enter the origin-detection waiting state. For the Counter display, the contact point of the connected Linear Gage must be pushed in and the origin must be passed over.



#### 3 Check that the counter value is shown on the Display.

- 4** Check that the counter value on the Counter changes by moving the contact point of the Linear Gage up and down.

### **Tips**

- When checking the connection, since the parameters are not set, the measured values may not be accurate depending on the gage resolution.
- Gages with the scale reference-point signal output function have their own origin in the inside of the gage. When the spindle is moved, a signal is generated at the moment when it passes through the origin. The preset position is reproduced based on this.
- Origin detection is normally performed only when the power is turned on, the Counter will wait for re-detection after the Preset or tolerance setting is set with the origin re-detection parameter, or when the HOLD signal is raised.  
For details about the origin re-detection parameters, see  "3.1 Parameter Setting Method" (page 12).
- If the HOLD signal is input again during origin re-detection, the origin re-detection will be canceled except during error cancellation.
- If there is no external output unit, connect the RS-232C connecting cable to the PC and PLC, input the communication command, and check whether the counter value is output. For details about parameters related to communication, see  "6 Parameter Setting Method (Setting with the EV Counter Main Body)" (page 67), and for details about communication commands, see  "5.1 RS-232C Communication Function" (page 40).

# 3 Setting Parameters

This chapter explains the setting method when using the D-EV External Display Unit.

For details about the setting method when not using the D-EV External Display Unit, see [6] "6 Parameter Setting Method (Setting with the EV Counter Main Body)" (page 67).

## 3.1 Parameter Setting Method

Parameters are set in Parameter mode. As an example, the procedure for using the Linear Gauge with a resolution of 5  $\mu\text{m}$  with the EV-16P is explained.

**Tips** Describes how to set the parameters using the D-EV External Display Unit (option).  
For details about setting with the EV Counter main body only, see [6] "6 Parameter Setting Method (Setting with the EV Counter Main Body)" (page 67).

### 1 Connect to power.

- » The Counter enters the stand-by state.

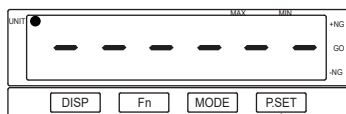

### 2 The Counter enters Parameter mode.

- 1 Press and hold [Fn], and then press [P.SET].
- » Parameter mode is displayed.

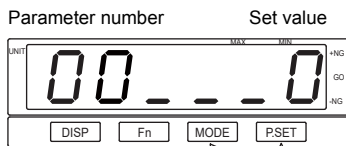

### 3 Change parameter set values.

- 1 Press [P.SET] once to set the set value to 1.
- » The set value changes to 1.

**Tips** If the set value is 0, view the parameter values. The set value cannot be changed. To change the parameter values, set the set value to 1.

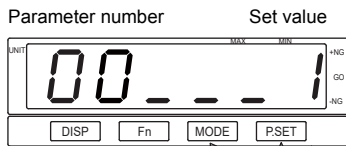



### 3 Setting Parameters

#### 4 Change the parameter number of INPUT A.

- 1 Repeatedly press [Fn] to advance the parameter number to 12.
  - » The current set value of parameter number 12 of INPUT A will be displayed.  
(Parameter number 12 sets the resolution.)

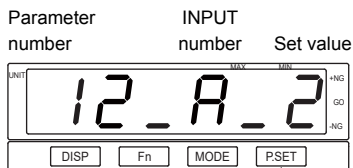

#### 5 Change parameter set values.

- 1 Repeatedly press [P.SET] to set the set value to 1.
  - » The resolution of the Linear Gage connected to INPUT A is set to 5  $\mu\text{m}$ .

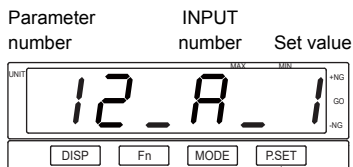

#### 6 Change the parameter number of INPUT B.

- 1 Press [Fn].
  - » The current set value of parameter number 12 of INPUT B is displayed.

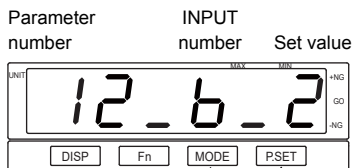

#### 7 Change parameter set values.

- 1 Repeatedly press [P.SET] to set the set value to 1.
  - » The resolution of the Linear Gage connected to INPUT B is set to 5  $\mu\text{m}$ .

**Tips** Repeat steps 5 through 6 to set the resolution of the connected Linear Gage.

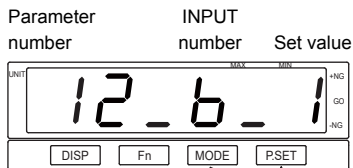

#### 8 Set the Counter to the stand-by state.

- 1 Press and hold [Fn], and then press [P.SET].
  - » The Counter returns to the stand-by state.

## 3.2 Overview of Setting Parameters

This section gives an overview of setting parameters.

- Tips**
- The following figure does not show the steps for setting parameters.
  - When setting parameters, each time you press [Fn], the parameter number will advance from 00. When the number advances to the last number, it then returns to 00.
  - Be sure to set the parameters enclosed within a solid line. Perform the parameter settings enclosed with a dashed line as necessary.

**Basic parameters**

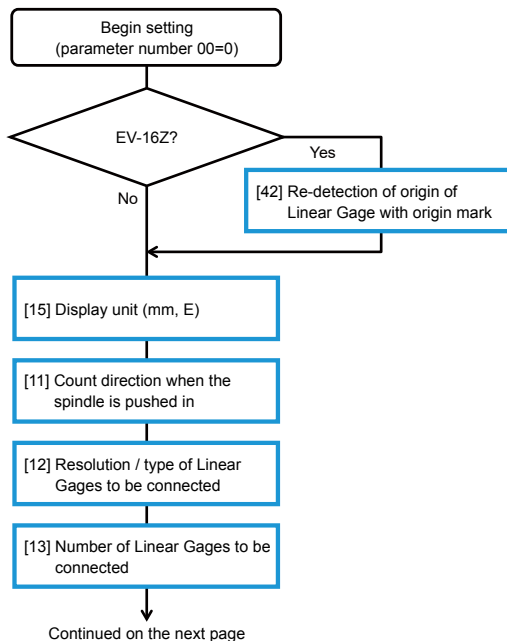

For details about basic parameters, see "3.3 Basic Parameters" (page 17).

### 3 Setting Parameters

#### Advanced parameters

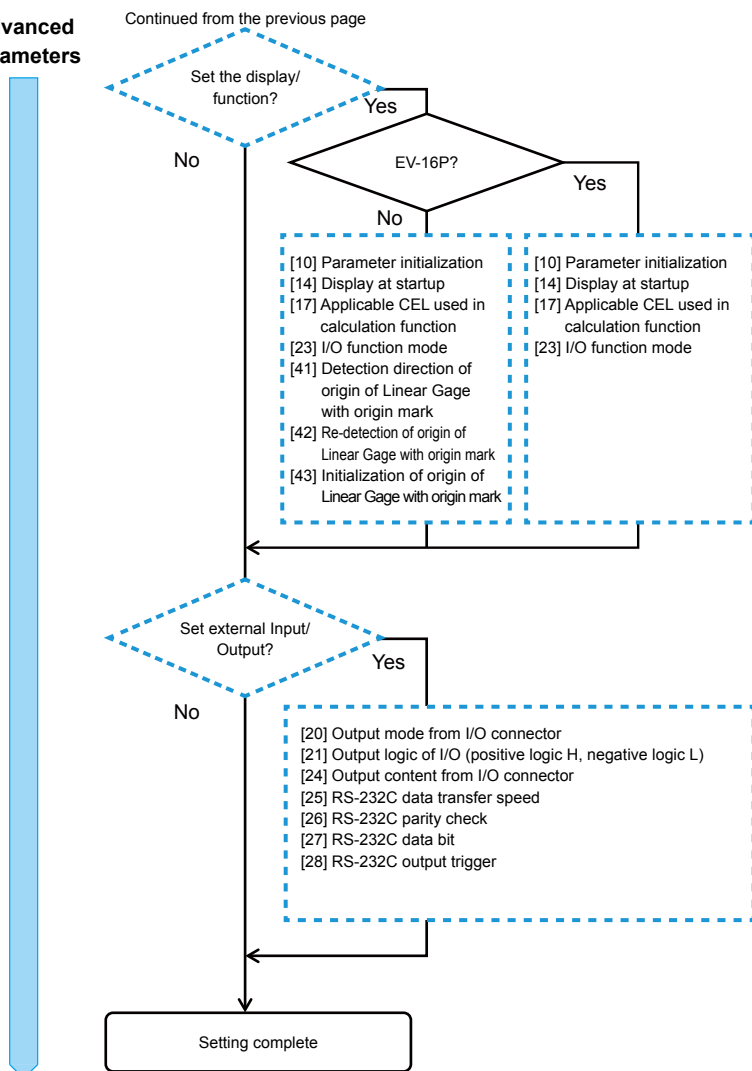

For details about advanced parameters, see "3.4 Advanced Parameters" (page 19).

## 3.2.1 Internal Structure of the Counter

The EV Counter has six gage input connectors (INPUT A to F), and six Linear Gages can be connected simultaneously. It also has six internal counters referred to as CEL (CEL1 to 6).

The EV Counter has a function called gage selector, with which multiple CELs can be assigned to one gage. Using this function, different origins and tolerances can be set for one gage.

Below is a schematic diagram of the configuration.

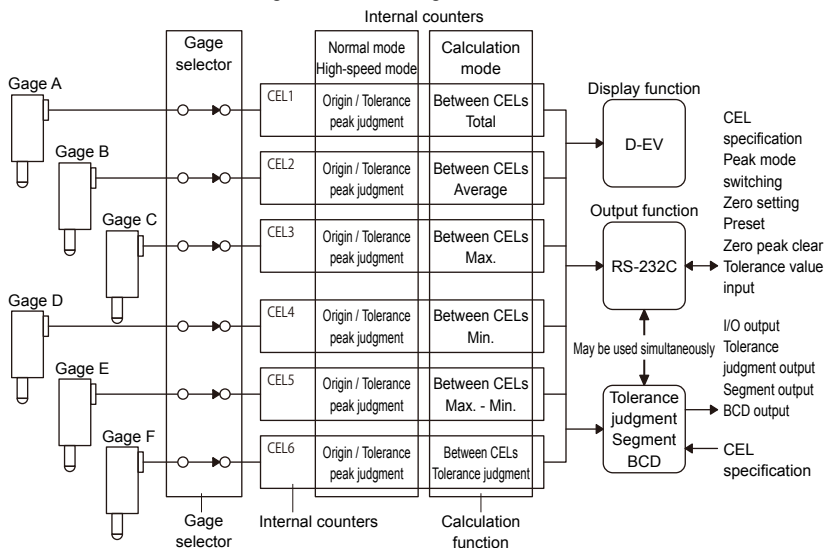

Consider which data to output from the I/O connector, and each CEL mode can be selected by changing the setting of the I/O function mode (parameter no.22). For details, see ["5.3 I/O Connector Terminal Function"](#) (page 47).

The counter value and calculation result of each CEL when the mode is set are as follows.

Set value	CEL1	CEL2	CEL3	CEL4	CEL5	CEL6
0	Origin / tolerance / peak measurement (Normal mode)					
1	Between CELs Total	Between CELs Average	Between CELs Max.	Between CELs Min.	Between CELs Max. - Min.	Calculation result tolerance judgment
2	Origin / tolerance / peak measurement (High-speed mode)					

## 3.3 Basic Parameters

This section explains the basic parameters related to measuring. Be sure to set these settings before measuring.

- Tips**
- Correct measurement results may not be obtained if the settings are incorrect.
  - The circles in the Counter model columns in the following table indicate whether a parameter number that is displayed on the Counter is valid or invalid (● : valid, ○ : invalid).

No.	Setting item	Description/Allowable set values (The values in bold indicate the default value.)	Counter model		
			P	Z	D
00	Parameter execution content (reference, change)	<b>0: Refers to the parameter.</b> 1: Changes parameter setting. 2: Use prohibited 3: Use prohibited Do not set other than "0" or "1".	●	●	●
11	Counter direction when the spindle is inserted	<b>0: Counts in the + direction.</b> 1: Counts in the - direction. Can be set per axis (for each INPUT number).	●	●	●
12	Resolution/type of Linear Gage to be connected (EV-16D) <sup>*1</sup>	<ul style="list-style-type: none"> <li>• EV-16P/Z               <ul style="list-style-type: none"> <li>0: 10 μm</li> <li>1: 5 μm</li> <li><b>2: 1 μm</b></li> <li>3: 0.5 μm</li> <li>4: 0.1 μm</li> </ul> </li> <li>• EV-16D               <ul style="list-style-type: none"> <li>0: INC (LGS-1012)</li> <li><b>1: ABS (LGS-1012P)</b></li> <li>2: ABS ORG</li> </ul> </li> </ul> Can be set per axis (for each INPUT number).	●	●	●
13	Number of Linear Gages to be connected (number of axes to be used) <sup>*2 *3</sup>	<b>6: Six axes</b> 5: Five axes 4: Four axes 3: Three axes 2: Two axes 1: One axis	●	●	●

### 3 Setting Parameters

No.	Setting item	Description/Allowable set values (The values in bold indicate the default value.)	Counter model		
			P	Z	D
15	Display unit (mm, E) **4	<b>0: mm<sup>3</sup></b> 1: E (= 1/24.5 of mm display) Even if parameter initialization is performed, it does not return to the initial value (0: mm).	●	●	●

\*1 All zero points, the Preset value and tolerance value that had been set will be cleared if the setting is changed.

\*2 An error occurs if the actual number of connected Linear Gages is different to the parameter settings.

Number of Linear Gages to be connected (number of axes to be used) > number of gages

: Displays / outputs [Error 40].

Number of Linear Gages to be connected (number of axes to be used) < number of gages

: Displays / outputs the gage set by the number of connected Linear Gages.

\*3 It is related to the "Applicable CEL used in calculation function" parameter.

For details, see  "3.5.1 Details of the Available Axis Designation Parameters" (page 22).

\*4 When setting, the UNIT indicator lights in green.

## 3.4 Advanced Parameters

This section explains the parameters related to the display, functions, and external output of the Counter. Configure the settings appropriate to your application.

- Tips**
- Correct measurement results may not be obtained if the settings are incorrect.
  - The circles in the Counter model columns in the following table indicate whether a parameter number that is displayed on the Counter is valid or invalid (● : valid, ○ : invalid).

No.	Setting item	Description/Allowable set values (The values in bold indicate the default value.)	Counter model		
			P	Z	D
10	Parameter initialization (implement / do not implement)	<b>0: Do not initialize.</b> 1: Initializes all parameters except display unit. After the initialization, returns to initial value (0: Do not initialize).	●	●	●
14	Display at startup	EV-16P/D <b>0: [----] Display</b> 1: [0.000] Display EV-16Z <b>0: [----] Display</b> 1: Origin detection wait indication	●	●	●
17	Applicable CEL used in calculation function <sup>1</sup>	<b>0: CEL1, 2</b> 1: CEL1, 2, 3 2: CEL1, 2, 3, 4 3: Available axis designated CEL <sup>2</sup> To execute the calculation, set parameter number 22 to [1: Calculation mode].	●	●	●
20	Output mode from I/O connector	<b>0: Command</b> (data output using sync control via HOLD and READY) <b>1: Interval</b> (data output at counter internal timing) For details, see  "5.3 I/O Connector Terminal Function" (page 47).	●	●	●

### 3 Setting Parameters

No.	Setting item	Description/Allowable set values (The values in bold indicate the default value.)	Counter model		
			P	Z	D
21	Output logic of I/O (positive logic H, negative logic L) <sup>3</sup>	Output logic settings differ depending on the setting of parameter number 23. <ul style="list-style-type: none"> <li>Parameter no. 23: 0 or 1  <b>0: Output terminal is L.</b>                      1: Output terminal is H.</li> <li>Parameter no. 23: 2  <b>0: H when output 1</b>                      1: L when output 1</li> </ul>	●	●	●
22	I/O function mode	<b>0: Normal mode</b> 1: Calculation mode 2: High-speed mode When selecting [1: Calculation mode], specify the applicable CEL to be used for calculation with parameter number 17.	●	●	●
23	Output content from I/O connector	<b>0: Tolerance judgment</b> 1: Segment output 2: BCD output	●	●	●
25	RS-232C data transfer speed <sup>4</sup>	0: 4800bps <b>1: 9600bps</b> 2: 19200bps	●	●	●
26	RS-232C parity check <sup>4</sup>	0: None 1: Odd number <b>2: Even number</b>	●	●	●
27	RS-232C data bit <sup>4</sup>	<b>0: 7bit</b> 1: 8bit	●	●	●
28	RS-232C output trigger <sup>4</sup>	<b>0: HOLD</b> 1: RS-232C output [1: RS-232C output] outputs data from the RS-232C connector when triggered by the HOLD input from the I/O connector. (In this case, the RS-232C command becomes invalid.)	●	●	●
41	Origin detection direction of Linear Gage with origin mark	<b>0: Spindle movement + direction</b> 1: Spindle movement - direction Can be set per axis.	○	●	
42	Re-detection of origin of Linear Gage with origin mark <sup>5</sup>	Sets whether to wait for the origin to be detected without turning off the power in the case of an abnormal stop. <b>0: Invalid</b> 1: Valid	○	●	



### 3 Setting Parameters

No.	Setting item	Description/Allowable set values (The values in bold indicate the default value.)	Counter model		
			P	Z	D
43	Origin initialization of Linear Gage with origin mark (When the power is turned on.)	<b>0: Do not initialize.</b> 1: Initialize When [1: Initialize] is selected, the origin of the Linear Gage is initialized when the power is turned on. After the initialization, the set value will return to initial value (0: Do not initialize).	○	●	

\*1 The calculation function is set as follows for each CEL (1 through 6).

CEL number	Calculation function	CEL number	Calculation function
CEL1	Between CELs Total	CEL4	Between CELs Max.
CEL2	Between CELs Average	CEL5	Between CELs Max. - Min.
CEL3	Between CELs Max.	CEL6	Calculation result tolerance judgment

**Tips** When using the calculation function, use the same resolution for the gages to be connected. If a different gage resolution is used, Error 70 occurs and calculation cannot be performed.

\*2 When parameter set value 3 (CEL set by the number of Linear Gages to be connected (number of axes to be used)) is selected, the CELs used for the calculation are as follows.

Set value of the number of Linear Gages to be connected (number of axes to be used)	CELs used for calculation
6	1, 2, 3, 4, 5, 6
5	1, 2, 3, 4, 5
4	1, 2, 3, 4
3	1, 2, 3
2 or 1	1, 2

\*3 The output logic of the input signal, NORMAL, READY, START, EXTEND is fixed.

\*4 Turn off the power after changing the setting. The setting will be enabled when you turn on the power again.

\*5 When the setting is enabled, the Counter will wait for the origin re-detection when the HOLD signal is raised. If the HOLD signal is input again during origin re-detection, the origin re-detection function will be canceled (except during error detection).

## 3.5 Setting Example

### 3.5.1 Details of the Available Axis Designation Parameters

The EV Counter has six internal counters (CEL1 through CEL6). The data of the Linear Gages connected to the gage input connectors A to F are displayed / output as data of CEL1 to CEL6 respectively.

Gage selector	By setting the parameters, you can connect the gage signal to the internal counter, in manner of one to one or one to many. Therefore, multiple origins and tolerances can be set for one gage.
Internal counters	Origin setting, peak measurement, and tolerance setting can be performed individually for the six internal counters (CEL1 through CEL6).
Calculation function	There are different calculation functions for each internal counter and calculations can be performed between counters specified by parameters. CEL1: Between CELs Total            CEL2: Between CELs Average CEL3: Between CELs Max.            CEL4: Between CELs Min. CEL5: Between CELs Max. - Min.    CEL6: Calculation result tolerance judgment
Output function	Selects and outputs from RC-232C, BCD, tolerance judgment, segment. The CEL to be output can be selected with the RS-232C command or SET signal.
High-speed output function	Outputs the data of the CEL specified by the output CEL specification at high speed. Data output interval in High-speed mode    : 5 ms (Data output interval in Normal mode        : 30 ms)
Display function	The content of each cell is displayed in D-EV.

### 3 Setting Parameters

The relationship between the parameter set by the number of connected Linear Gages and CEL is shown below.

- Number of Linear Gages to be connected (parameter number 13): Set value 1 (one gage used)
- Applicable CEL used in calculation function (parameter number 17): Set value 3 (available axis designated CEL)

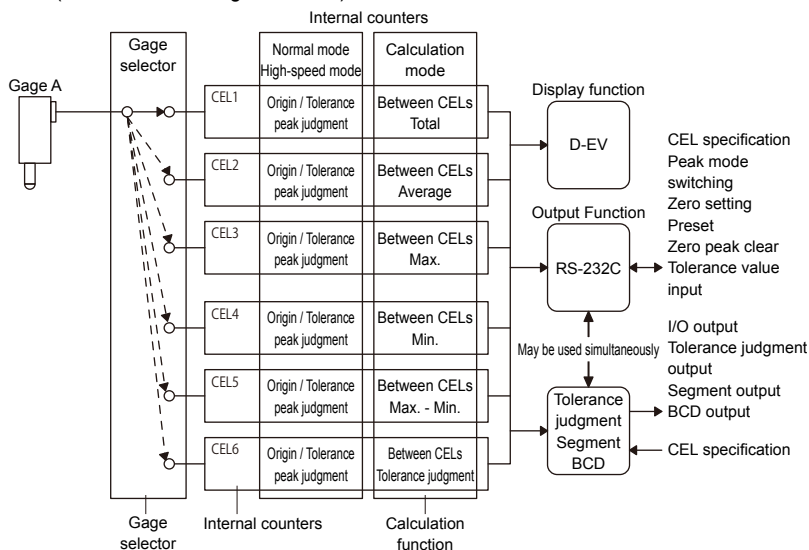

CEL number	CEL1	CEL2	CEL3	CEL4	CEL5	CEL6
INPUT number	INPUT A					

- Number of Linear Gages to be connected (parameter number 13): Set value 2 (two gages used)
- Applicable CEL used in calculation function (parameter number 17): Set value 3 (available axis designated CEL)

CEL number	CEL1	CEL2	CEL3	CEL4	CEL5	CEL6
INPUT number	INPUT A	INPUT B	INPUT A	INPUT B	INPUT A	INPUT B

### 3 Setting Parameters

- Number of Linear Gages to be connected (parameter number 13): Set value 3 (three gages used)
- Applicable CEL used in calculation function (parameter number 17): Set value 3 (available axis designated CEL)

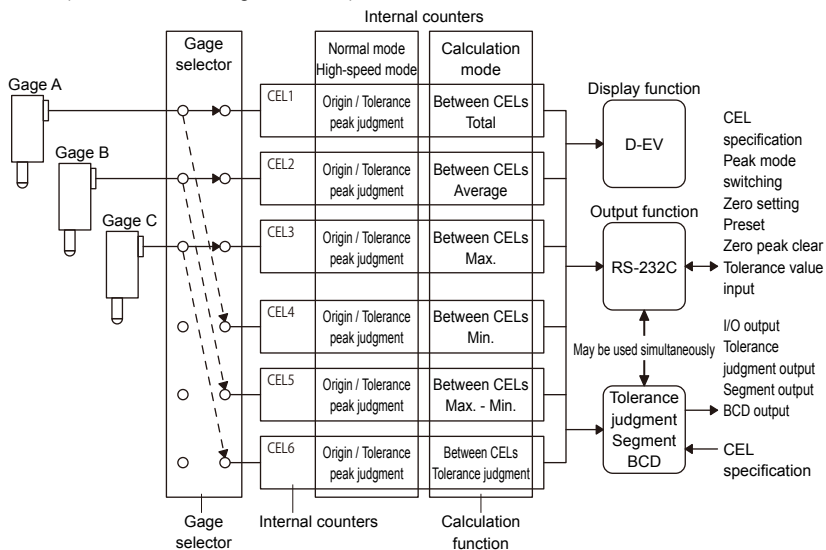

CEL number	CEL1	CEL2	CEL3	CEL4	CEL5	CEL6
INPUT number	INPUT A	INPUT B	INPUT C	INPUT A	INPUT B	INPUT C

- Number of Linear Gages to be connected (parameter number 13): Set value 4 (four gages used)
- Applicable CEL used in calculation function (parameter number 17): Set value 3 (available axis designated CEL)

CEL number	CEL1	CEL2	CEL3	CEL4	CEL5	CEL6
INPUT number	INPUT A	INPUT B	INPUT C	INPUT D	INPUT A	INPUT B

### 3 Setting Parameters

- Number of Linear Gages to be connected (parameter number 13): Set value 5 (five gages used)
- Applicable CEL used in calculation function (parameter number 17): Set value 3 (available axis designated CEL)

CEL number	CEL1	CEL2	CEL3	CEL4	CEL5	CEL6
INPUT number	INPUT A	INPUT B	INPUT C	INPUT D	INPUT E	INPUT A

- Number of Linear Gages to be connected (parameter number 13): Set value 6 (six gages used)
- Applicable CEL used in calculation function (parameter number 17): Set value 3 (available axis designated CEL)

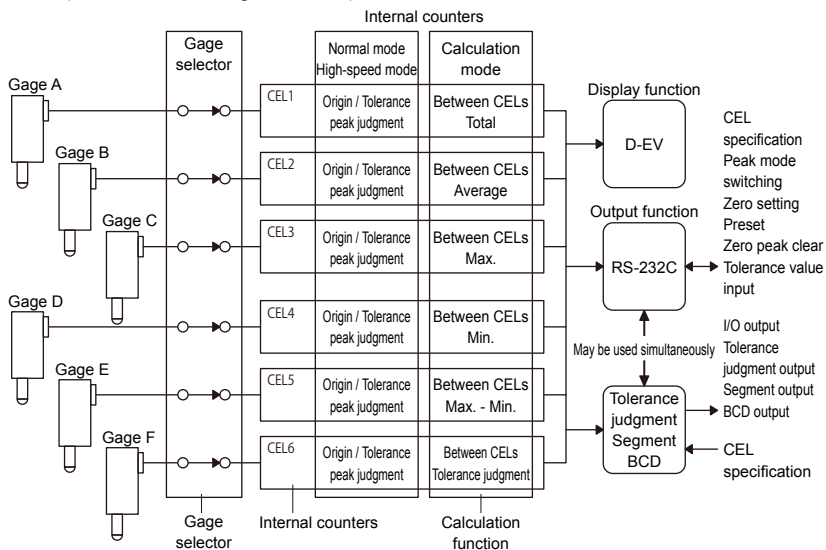

# 4 Basic Operations

This chapter explains the basic operation of the EV Counter using the D-EV.

## 4.1 Precautions for Power-On

### 1 Connect power.



For details, see  "2.3.4 Confirm the Connection (When the D-EV Is Used)" (page 10).

Do not move the gage contact point or operate the keys until the device enters the stand-by state.

## 4.2 Display / Operation CEL Selection (When the D-EV Is Used)

When using the External Display Unit (D-EV), press [DISP] to switch the displayed CEL.

The code displayed when pressing [DISP] or the GAGE indicator determines what is displayed in the Display.

- Tips**
- While [DISP] is pressed down, the CH number and gage input connector number are displayed in the Display. When the key is released, the Counter will display the Counter display.
  - The CH number (01 through 99) is automatically assigned starting from the first EV Counter when RS LINK is connected. If there is only one counter, the CH numbers will be 01 through 06. This corresponds to data of CEL 1 through CEL6 respectively. For details, see  "5.2 RS LINK Function" (page 45).
  - The gage indicator on the D-EV shows the currently displayed CH and the all axes tolerance judgment bar. For details about the all axes tolerance judgment bar, see  "4.6 Tolerance Judgment (When the D-EV Is Used)" (page 37).

○ Off, ● On green

Details	Indicator	Details	Indicator
CH1	○ ○ ●	CH2	○ ● ○
CH3	○ ● ●	CH4	● ○ ○
CH5	● ○ ●	CH6	● ● ○
All axes tolerance judgment bar	● ● ●		

## 4 Basic Operations

- D-EV screen transition diagram

While [DISP] is pressed down, the CH number and gage input connector number are displayed in the Display. When the key is released, the Counter will display the Counter display.

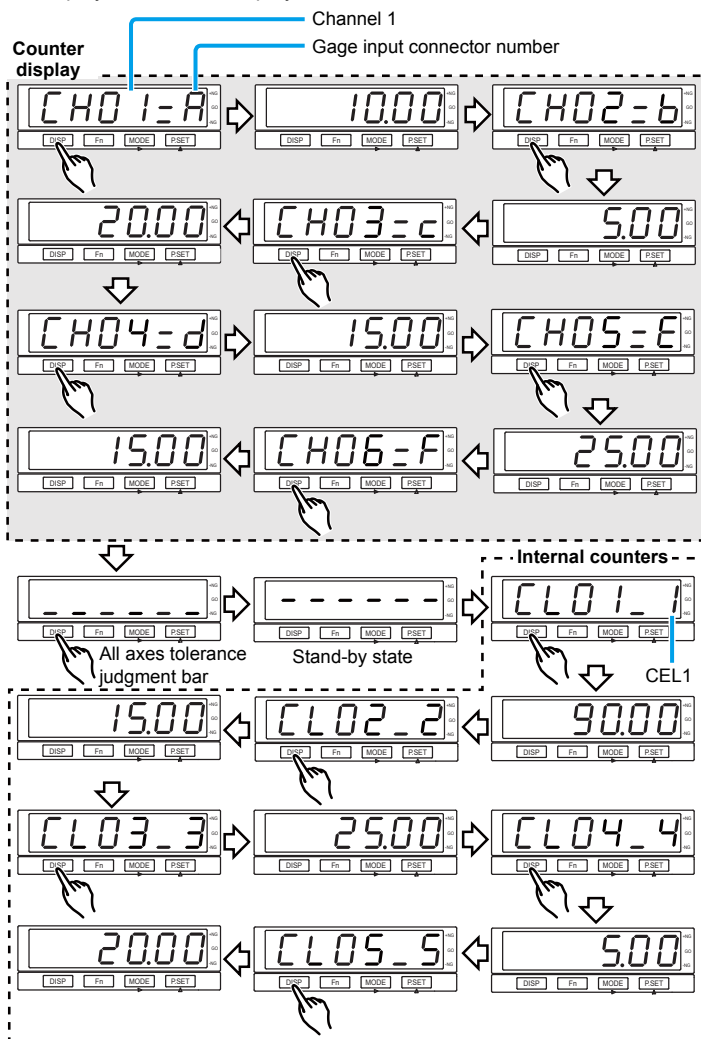

### 4.3 Input of Preset Value / Tolerance Value (When the D-EV Is Used)

When the D-EV is used, up to 6 digits of set value can be input.

As an example, the procedure for setting the Preset value reference point to 1.000 mm, the lower tolerance limit value to -995.000, and the upper tolerance limit value to 995.000 is explained.

- Tips**
- When Calculation mode is displayed, Preset values / tolerance values cannot be set. Please switch the mode to apply settings.
  - To cancel the input, press [Fn]. The procedure is moved to the next setting item.
  - Set the tolerance limit setting as follows: Lower tolerance limit  $\leq$  Upper tolerance limit. A tolerance setting error (Err 90) will result if incorrect settings are applied. In this case, press [Fn] and reapply the settings, starting from the lower tolerance limit.
  - Preset values and tolerance values are backed up in memory even when the power is turned off.
  - The set values for Preset values / lower tolerance limit value / upper tolerance limit value set at shipment are as follows (for 1  $\mu\text{m}$  gage):  
00000.000 / -99999.999 / 99999.999  
(D-EV display: 000.000 / -F99.999 / F99.999)
  - For the EV-16D, the resolution is automatically set starting from the connected Linear Gage. Set the Preset value / tolerance value with the Linear Gage is connected.

#### 1 Press [DISP] to select the CEL.

- » The counter value of the selected CEL is displayed / output to the D-EV.

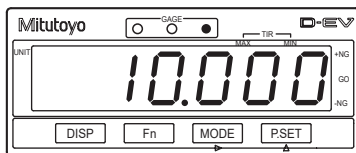



## 4 Basic Operations

### 2 Press [Fn].

- » GAGE indicator blinks in green.
- » The current Preset value is displayed.

**Tips** Up to 8 digits can be set using RS-232C communication. If a value of 7 digits or more is set, "F" will be displayed in the most significant digit, e.g., "F34.567" on the D-EV.

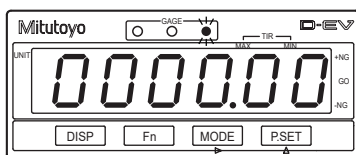

### 3 Input the Preset set value.

- 1 Press [MODE] to select the input digit.
  - » The selected digit will blink.

**Tips** The input digit will shift to the right each time [MODE] is pressed.

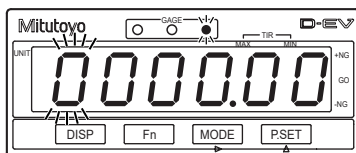

- 2 Press [P.SET].
  - » The blinking value is changed.

**Tips** Set the  $\pm$  sign in the most significant digit.  
Values are switched in the order of 0, 1, ... 9, -0, -1, ... -9,.

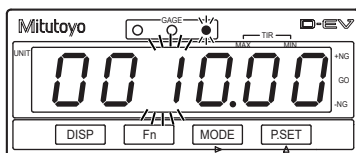

- 3 Repeat steps 1 through 2 and enter values up to the last digit.

- 4 With the least significant digit blinking, press [MODE].
  - » The input value is fixed and the value stops blinking.

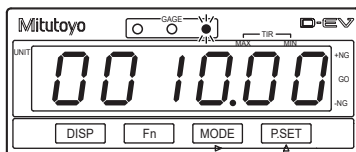
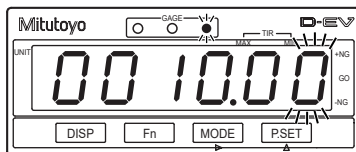

## 4 Basic Operations

### 4 Press [Fn].

- » GAGE indicator blinks in amber.
- » The current lower tolerance limit is displayed.

**Tips** Up to 8 digits can be set using RS-232C communication. If a value of 7 digits or more is set, "F" will be displayed in the most significant digit, e.g., "F34.567" on the D-EV.

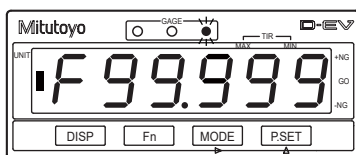

### 5 Input the set value of the lower tolerance limit.

- 1 Press [MODE] to select the input digit.
  - » The selected digit will blink.

**Tips** The input digit will shift to the right each time [MODE] is pressed.

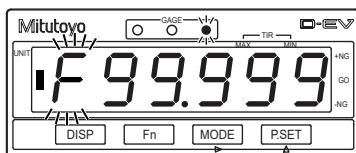

- 2 Press [P.SET].
  - » The blinking value is changed.

**Tips** Set the  $\pm$  sign in the most significant digit. Values are switched in the order of 0, 1, ... 9, -0, -1, ... -9, 0.

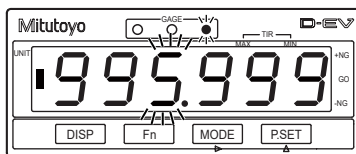

- 3 Repeat steps 1 through 2 and enter values up to the last digit.

## 4 Basic Operations

- 4 With the least significant digit blinking, press [MODE].
  - » The input value is fixed and the value stops blinking.

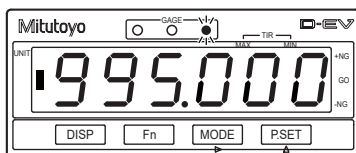
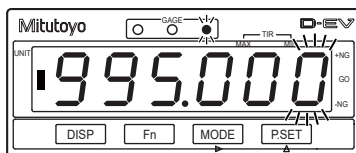

## 6 Press [Fn].

- » GAGE indicator blinks in red.
- » The current upper tolerance limit is displayed.

**Tips** Up to 8 digits can be set using RS-232C communication. If a value of 7 digits or more is set, "F" will be displayed in the most significant digit, e.g., "F34.567" on the D-EV.

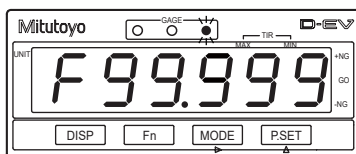

## 7 Input the set value of the upper tolerance limit.

- 1 Press [MODE] to select the input digit.
  - » The selected digit will blink.

**Tips** The input digit will shift to the right each time [MODE] is pressed.

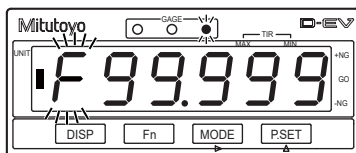

## 4 Basic Operations

- 2 Press [P.SET].
  - » The blinking value is changed.

**Tips** Set the  $\pm$  sign in the most significant digit.  
Values are switched in the order of 0, 1, ... 9, -0, -1, ... -9, 0.

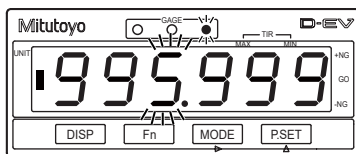

- 3 Repeat steps 1 through 2 and enter values up to the last digit.
- 4 With the least significant digit blinking, press [MODE].
  - » The input value is fixed and the value stops blinking.

**Tips** If [Fn] is pressed after setting the upper tolerance limit, it returns to the measured value display.  
To apply settings again, press [Fn] to display the item to be set.

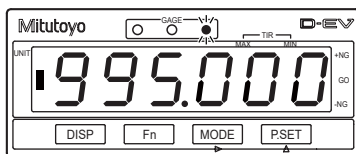
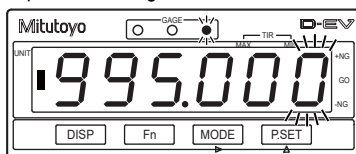

## 4.4 Preset (When the D-EV Is Used)

Set the current value of the Counter to the Preset value set by  "4.3 Input of Preset Value / Tolerance Value (When the D-EV Is Used)" (page 28). (Preset value settings at shipment: 0)

### NOTICE

- The EV Counter can count up to 8 digits, but the D-EV can only display up to 6 digits. When the counter value reaches 7 digits or more, the display of the most significant digit on the D-EV becomes "F". When the counter value returns to 6 digits or less, the D-EV returns the normal display.  
Example: EV Counter main body counter value: 1000.001  
D-EV display: F00.001
- For ABS\_ORG of EV-16D, it takes about 4 seconds for the preset call. Do not move the spindle during this time. The zero point may shift.
- The preset effective number of times in ABS, ABS\_ORG is one million times.

**Tips** When Calculation mode is displayed, Preset values cannot be set. Please switch the mode to apply settings.

- 1 Press [DISP] to select the CEL.

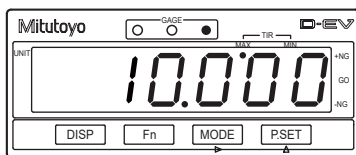

- 2 Press [MODE] to select the current value mode.

- » Peak mode indicator lights on the D-EV.

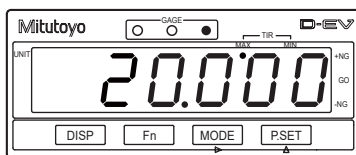

## 4 Basic Operations

---

### 3 Press [P.SET].

- » The current value (displayed value) of the selected CEL is replaced with the Preset value.
- » The peak value of the selected CEL will be cleared, and the following will be applied: MAX = MIN = current value, TIR = 0

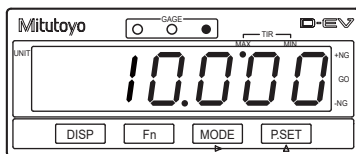

## 4.5 Peak Mode Setting

The maximum value, the minimum value, and TIR value are constantly calculated in the Counter. By switching the mode, you can display the counter value according to the intended application on the D-EV.

Mode	Description
Normal measurement	Counts the movement (displacement) of the contact point of the Linear Gage, and then displays the counter value successively.
Max. hold measurement	Displays the maximum value (MAX) measured during the measurement. The display will not change until a new maximum value is measured.
Min. hold measurement	Displays the minimum value (MIN) measured during the measurement. The display will not change until a new minimum value is measured.
TIR measurement	Displays TIR value during the measurement = TIR (maximum value - minimum value). The display will not change until either a new maximum value or minimum value is measured.

### 4.5.1 Procedure for Switching Peak Mode (When the D-EV Is Used)

This section explains how to switch Peak mode.

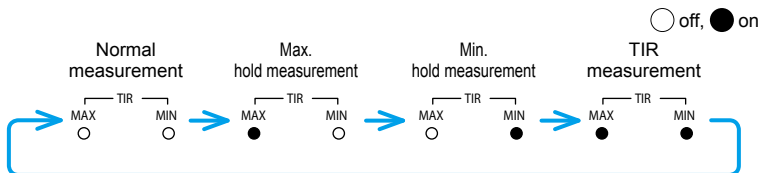

**Tips** When Calculation mode is displayed, Peak mode cannot be switched. Please switch the mode to apply settings.

- 1 Press [DISP] to select the CEL number.
  - » The measured value of the selected CEL is displayed / output to the D-EV.
- 2 Repeatedly press [MODE] until the desired mode is displayed.
  - » The mode will switch as follows:



### 4.5.2 Procedure for Clearing the Peak Value (When the D-EV Is Used)

This section explains how to clear the peak value in Peak mode.

- Tips**
- When [P. SET] is pressed in normal Measurement mode, both the peak value clear and the preset setting are executed.  
For details, see  "4.4 Preset (When the D-EV Is Used)" (page 33).
  - When [P. SET] is pressed, the peak value of all CELs assigned the same INPUT number is cleared. Example: When designation of available axis = 2, clearing the peak value of CEL1 with [P. SET] also clears the peak value of CEL3 and CEL5.  
For details, see  "3.3 Basic Parameters" (page 17),  "3.4 Advanced Parameters" (page 19).
  - When Calculation mode is displayed, Peak mode cannot be switched.  
Please switch the mode to apply settings.

**1** Press [DISP] to select the CH number.

- » The measured value of the selected CH is displayed / output to the D-EV.

**2** Press [MODE] to select either MAX, MIN, or TIR mode.

- » The Peak mode indicator selected for the D-EV lights.  
For details, see  "4.5 Peak Mode Setting" (page 35).

**3** Press [P.SET].

- » The peak value is cleared.

**Tips** The following is applied: MAX = MIN = current value, TIR = 0



# 4.6 Tolerance Judgment (When the D-EV Is Used)

The judgment result of the set tolerance value and counter value can be confirmed by one of the following.

- Confirm by the color of the GAGE indicator.
- Confirm by the display of the all axes tolerance judgment bar.
- Output the result by I/O connector.

For details about how to switch the D-EV display, see  "4.2 Display / Operation CEL Selection (When the D-EV Is Used)" (page 26).

For details about how to set the tolerance value, see  "4.3 Input of Preset Value / Tolerance Value (When the D-EV Is Used)" (page 28).

For details about I/O output, see  "5.3 I/O Connector Terminal Function" (page 47).

## 4.6.1 Tolerance Judgment Result by GAGE Indicator

The lit color of the GAGE indicator will change as shown below according to the tolerance judgment result.

Tolerance judgment result display (example: CEL1)

-NG: Counter value < Lower tolerance limit



Amber indicator on

GO: Lower tolerance limit ≤ Counter value ≤ Upper tolerance limit

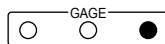

Green indicator on

+NG: Upper tolerance limit < Counter value



Red indicator on

### 4.6.2 Tolerance Judgment Result by All Axes Tolerance Judgment Bar Display

When the D-EV is used, if the display is set to all axes tolerance judgment bar display, the display will be as shown below.

Tolerance judgment result display (example: all axes tolerance judgment bar display)

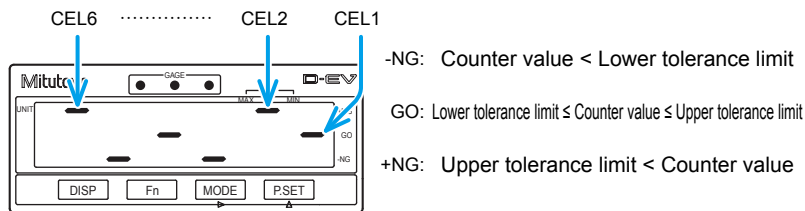

The horizontal direction of the display represents CEL1, CEL2, ....., CEL6 from the right side, and shows each CEL.

The vertical direction represents +NG, GO, -NG from the upper side, and shows the judgment result.



Therefore, the tolerance judgment result in the case of the above figure is the following result.

- GO judgment: CEL1, CEL4
- +NG judgment: CEL2, CEL6
- -NG judgment: CEL3, CEL5

- Tips**
- Operation other than [DISP] is disabled while the all axes tolerance judgment bar is displayed.
  - Both +NG and -NG lights for CELs where an error has occurred.

### 4.7 Error Cancellation Method (When the D-EV Is Used)

Errors can be canceled by one of the following operations.

- Press [DISP] to display the CEL number where the error occurred, and press [P. SET].
- Input the HOLD signal (I/O connector pin number 36). For details about error cancellation timing, see  "5.3.6 Timing Chart" (page 61).
- Communication command Enter the CS command from a PC or PLC. For details, see  "5.1.2 Communication Commands" (page 41).

- Tips**
- Error40 is displayed / output during error cancellation execution.
  - The GAGE indicator blinks during error cancellation execution.
  - Error cancellation execution time is 30 ms for EV-16P and EV-16Z, and maximum 8 s for EV-16D.
  - For EV-16Z, the contact point of the connected Linear Gage must be pushed in and the origin must be passed over.

# 5 External Input/Output Function

This product is equipped with the following interfaces that enable the connection of external equipment.

Interface	Connectable equipment	Functions
RS-232C connector	PC, PLC	<ul style="list-style-type: none"> <li>Data output to a PC, PLC</li> <li>Control from external system</li> </ul>
I/O connector	Equipment such as a switch or control unit	<ul style="list-style-type: none"> <li>Data output to PLC</li> <li>External control of the EV Counter</li> </ul>

**Tips** PLC: programmable logic controller

## 5.1 RS-232C Communication Function

By connecting to a PC or PLC via RS-232C, you can load measurement data and manipulate various settings of the EV Counter through remote operation.

### 5.1.1 Connections

#### Compatible plug and pin assignment

Compatible plug: D-sub 9-pin (female), inch screw specification

Cable: Use a commercial RS-232C cross-type connecting cable.

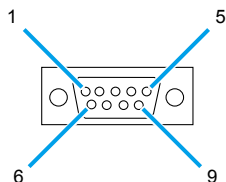

Pin number	Signal name	I/O
2	RXD	IN
3	TXD	OUT
4	DTR	OUT
5	GND	-
6	DSR	IN
7	RTS	OUT
8	CTS	IN
1, 9-15	NC	-

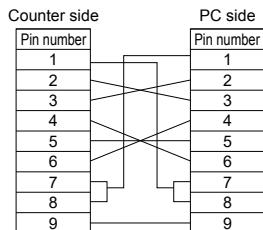

## 5 External Input/Output Function

### ■ Communication specification (conforming to EIA RS232C)

Item	Description
Home position	DTE (terminal definition) * Use a cross-type cable.
Communication method	Half-duplex, non-procedural mode
RS-232C data transfer speed	4800 bps/9600 bps/19200 bps
Bit configuration	Start bit: 1 Data bit: 7 bit / 8 bit (ASCII code, uppercase letters) Parity: None / even number / odd number Stop bit: 2

- Tips**
- Set communication conditions using parameters.  
For details, see  "3.4 Advanced Parameters" (page 19).
  - Use commercial terminal software for communication with a PC.

### 5.1.2 Communication Commands

This section explains the command format from a PC or PLC, output from the EV Counter, and operation details.

Command format	Corresponding output	Operation details	Notes
GA**CRLF	G#**, +01234.567CRLF	Outputs "Display value".	See *1.
CN**CRLF	CH**CRLF	Switches the display to "Current value".	See *2.
CX**CRLF	CH**CRLF	Switches the display to "Maximum value".	See *2.
CM**CRLF	CH**CRLF	Switches the display to "Minimum value".	See *2.
CW**CRLF	CH**CRLF	Switches the display to "TIR".	See *2.
CR**CRLF	CH**CRLF	Zero setting	
CL**CRLF	CH**CRLF	Clears the peak value.	
CP**,+01234567CRLF	CH**CRLF	Inputs the Preset value.	See *3.
CD**,+01234567CRLF	CH**CRLF	Entry of the lower tolerance limit value	See *3, *4.
CG**,+01234567CRLF	CH**CRLF	Entry of the upper tolerance limit value	See *3, *4.
CS**CRLF	CH**CRLF	Clears error.	

## 5 External Input/Output Function

Command format	Corresponding output	Operation details	Notes
CK**CRLF	CH**,%CRLF	Checks the HOLD status.	See *5, *7.
CT¥¥CRLF	CH¥¥,+01234.567CRLF	Calculation data output	See *6, *7.

- \*1 \*\*\*\* denotes an RS-232C Linear Gage channel number (01 through 99). ("00" means all channels.) Channels 01 to 06 correspond to CEL1 to CEL6, respectively.  
A "#" after "G" in the output data denotes the type of data (N: Current value, X: Maximum value, M: Minimum value, W: TIR).
- \*2 If Peak mode is switched using an RS command, data will not be backed up in internal memory.
- \*3 For the Preset value and tolerance set value, enter a value consisting of a +/- sign and an 8-digit of numeric value without a decimal point.
- \*4 For the tolerance setting, set it in the following order: CD (lower limit)→ CG (upper limit)  
An error will be output in the following cases. In this case, redo from the lower limit settings.
- The tolerance order is different.
  - Incorrect data was transmitted.
- \*5 The response output from the CK command (%) shows the HOLD status.  
%=0: Normal status, %=1: HOLD status
- \*6 Notes on outputting calculation data with the CT command  
This command is valid only when set value 1 (Calculation mode) is selected in parameter number 22 (I/O function mode).  
"¥¥" specifies the calculation method between axes specified in advance with the calculation axis designation parameter.

"¥¥" value			Operations
First counter	Second counter*	Third counter*	
01	07	13	Obtain "total value" for each specified axis.
02	08	14	Obtain "average value" for each specified axis.
03	09	15	Obtain "maximum value" between specified axes.
04	10	16	Obtain "minimum value" between specified axes.
05	11	17	Obtain "maximum value - minimum value" between specified axes.

- \* When two or more EV Counters are connected to the RS LINK, the second and subsequent "¥¥" values are as shown in the table above.
- \*7 The CK and CT commands cannot specify all channels. If all channels are specified, an error occurs.

- Tips**
- CRLF means CR (carriage return) plus LF (line feed).
  - The output when an error occurs is "CH\*\* ,Error\$\$CRLF". \$\$ is the error code. For details, see  "7.2.1 List of Error Codes" (page 76).

- Tips**
- After you have received a response output corresponding to the command, send the next command. If there is no response from your command, clear the communication buffer, wait 1 second or more, and then send the command again.
  - The RS communication function will be suspended during key operation (e.g., setting parameters, the Preset value, or tolerance values). Command and data output operations will resume when the Counter returns to a state where counting is possible.
  - To cancel the stand-by state, use "CS00CRLF" (all channels specified).
  - Although the output formats of the GA and CT commands are similar, note that the operation is different.  
GA command: Outputs the channel counter data specified by "##".  
CT command: Outputs the calculation result specified by "##".

### 5.1.3 Timing Chart

#### RS-232C command input and response output

(The set value of parameter no. 28 is 1.)

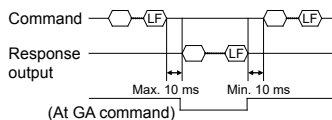

#### HOLD input and response output

(The set value of parameter no. 28 is 0.)

\* Values in square brackets indicate values for MAX, MIN, and TIR measurements.

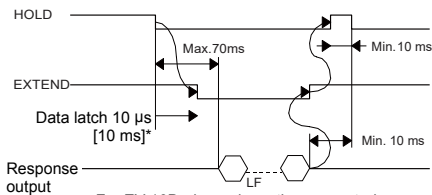

For EV-16D, depends on the connected gage.

#### Tips

- RS-232C output will be suspended during command operation.
- When connected to the RS LINK, EXTEND of the last EV Counter is valid.
- The EXTEND output is valid only when parameter number 20 (output mode from the I/O connector) is set value 1 (interval mode).
- During HOLD input, the D-EV UNIT indicator will blink.
- To output RS-232C with the HOLD input signal, select the set value 1 (RS-232C output) with parameter number 28 (output trigger of RS-232C). In this case, the RS-232C command becomes invalid.
- When set value 2 (High-speed mode) is selected in parameter number 22 (I/O function mode), set the output CEL to all CELs.



## 5.2 RS LINK Function

For PC (including SENSORPAK) or PLC control, you can control a maximum of 10 EV Counters using the RS LINK function.

### 5.2.1 Connections

Connect IN and OUT between the RS\_LINK connectors as shown in the following figure.

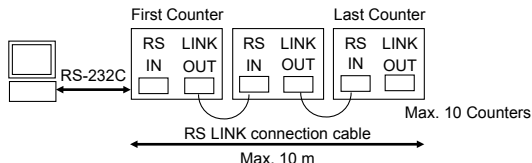

When the D-EV is connected as shown below, the D-EV displays the data of the EV Counter A.

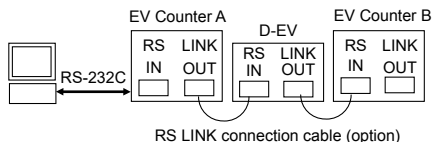

- Tips**
- Do not connect anything to the RS\_LINK connector (IN) of the first EV Counter or to the RS\_LINK connector (OUT) of the last EV Counter.
  - When the power switch is turned on and the settings are initialized, the CH number of the Linear Gages will be automatically assigned CH01, CH02, and CH03 from INPUT A of the first EV Counter in the order in which they are connected. (The second unit is set in the order CH07, CH08, CH09.)
  - The length of the RS LINK connection cable is up to 10 m for the whole system.  
For details, see "8.3 Option" (page 82).

- Tips** Contact Mitutoyo regarding systems of 10 or more Counters or a total cable length of 10 m or more.

### ■ Precautions for startup

- Either turn on the power switch of all EV Counters/D-EV simultaneously or turn on the power of each EV Counter/D-EV sequentially, beginning with the first EV Counter/D-EV.
- After startup, [- - - -] will blink, and then, after the initial settings have completed, the Counter enters the stand-by state, where [- - - -] is displayed. The stand-by state can be canceled with [P. SET], external HOLD signal, or RS command. For details, see  "7.2.1 List of Error Codes" (page 76).
- Parameter numbers relating to RS-232C (no. 25 through no. 28) can be modified only on the first EV Counter. If you modify a parameter, reset the power of all connected EV Counters.
- Set the parameter number 14 (display at startup) to the set value 0 ([- - - -]).

### 5.2.2 RS-232C Data Output Duration

The maximum output duration of the command to output all data (GA00CRLF) can be calculated with the following formula:

Maximum output duration [ms] = Number of connected Counters × 10 + Number of connection channels × 17 (8.5) + 6 (3)

**Tips** Transmission rate is 9600 bps. The values enclosed in ( ) show the case of 19200 bps.

Calculation example:

EV-16P 1 counter + Linear gage 6 CHs = Max. 118 ms (64 ms)

EV-16P 10 counters + Linear gage 60 CHs = Max. 1126 ms (613 ms)

- Tips**
- Processing time of the PC is not included.
  - For Linear Gage 60 CHs, data size is 900 bytes (15 bytes per Linear Gage one CH). Check the specifications of the PC on the receiving side.

## 5.3 I/O Connector Terminal Function

The tolerance judgment result of each CEL and measured data, etc., can be output to an external device.

Also, by inputting a signal from an external device, Preset, error cancel, peak clear, etc., of the specified CELs can be performed.

There are three types of modes for I/O functions: Normal mode, Calculation mode, and High-speed mode, and the tolerance judgment result output, BCD output, and segment output can be selected for each mode.

For details about parameter setting, see  "3 Setting Parameters" (page 12).

### 5.3.1 Connections

#### Compatible plug

Compatible plug:

- Option No. 02ADB440 (plug and cover set)
- Commercial plug 10136-3000PE (3M), cover 10336-52A0-008 (3M)
- Commercial plug DX40M-36P (HIROSE), cover DX30M-36-CV (HIROSE)

Cable: Use shielded wires and limit the connecting cable length to 3 m or less.

#### Input/Output circuit

##### Output circuit

Tolerance judgment result output,  
NORMAL, segment output

Transistor is on when the output is "L"  
(open collector).

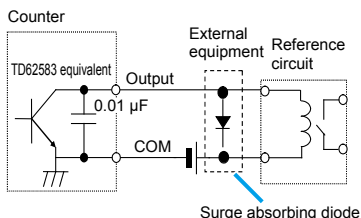

Output withstand voltage: Max. 24 V  
Output current: Max. 10 mA  
Output saturation voltage: Max. 0.7 V 60 V 100 mA or more

##### Input circuit

P.SET, HOLD, SET

Input is valid when the input voltage  
is "L".

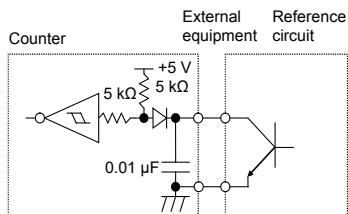

Input current: Max. 1 mA  
Input voltage: H = 4 V–24 V  
L = Max. 1 V  
Use open-collector output or relay output.

**NOTICE** When using relays, incorporate a surge-current-absorbing diode or a protective circuit. If no protection is incorporated, the IC in the Counter may be damaged.

### 5.3.2 Output Function (Normal Mode)

Normal mode is the setup mode at shipment. Normal mode can be used for general use.

Origin setting, tolerance setting, and Preset can be performed independently for each CEL.

In addition, as output functions, tolerance judgment result output (for each CEL independently), BCD output, and segment output (CEL switching type) can be performed.

#### ■ Tolerance judgment result output

Tolerance judgment results of the internal counters (CEL1 through CEL6) are output individually.

Judgment conditions	Measurement results
Measurement result < Lower tolerance limit value	-NG output
Lower tolerance limit value ≤ Measurement result ≤ Upper tolerance limit value	GO (OK) output
Upper tolerance limit value < Measurement result	+NG output

#### Tips

- To enable this function, select the following parameter.  
 Parameter no. 22 (I/O function mode): Set value 0 (Normal mode)  
 Parameter no. 23 (output content from the I/O connector): Set value 0 (tolerance judgment result output)
- For details about the timing chart, see  "5.3.6 Timing Chart" (page 61).
- To output total tolerance judgment, set parameter number 21 (output logic of I/O) to set value 1 (output pin: H). By wired-OR connecting the GO output of each CEL, the output becomes "H" when all the connected CELs are GO.

#### ● Pin assignment

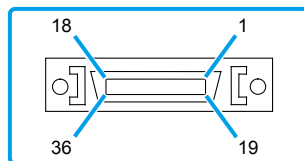

No.	Name	I/O	Functions	
1	COM	—	Common terminal of I/O circuit (internally connected to GND)	
2	COM	—		
3	CEL1_-NG	OUT	CEL1 tolerance judgment result output	-NG
4	CEL1_GO	OUT	CEL1 tolerance judgment result output	GO

## 5 External Input/Output Function

No.	Name	I/O	Functions
5	CEL1_+NG	OUT	CEL1 tolerance judgment result output +NG
6	CEL1_NOM	OUT	CEL1 error signal output*1
7	CEL2_-NG	OUT	CEL2 tolerance judgment result output -NG
8	CEL2_GO	OUT	CEL2 tolerance judgment result output GO
9	CEL2_+NG	OUT	CEL2 tolerance judgment result output +NG
10	CEL2_NOM	OUT	CEL2 error signal output*1
11	CEL3_-NG	OUT	CEL3 tolerance judgment result output -NG
12	CEL3_GO	OUT	CEL3 tolerance judgment result output GO
13	CEL3_+NG	OUT	CEL3 tolerance judgment result output +NG
14	CEL3_NOM	OUT	CEL3 error signal output*1
15	CEL4_-NG	OUT	CEL4 tolerance judgment result output -NG
16	CEL4_GO	OUT	CEL4 tolerance judgment result output GO
17	CEL4_+NG	OUT	CEL4 tolerance judgment result output +NG
18	CEL4_NOM	OUT	CEL4 error signal output*1
19	CEL5_-NG	OUT	CEL5 tolerance judgment result output -NG
20	CEL5_GO	OUT	CEL5 tolerance judgment result output GO
21	CEL5_+NG	OUT	CEL5 tolerance judgment result output +NG
22	CEL5_NOM	OUT	CEL5 error signal output*1
23	CEL6_-NG	OUT	CEL6 tolerance judgment result output -NG
24	CEL6_GO	OUT	CEL6 tolerance judgment result output GO
25	CEL6_+NG	OUT	CEL6 tolerance judgment result output +NG
26	CEL6_NOM	OUT	CEL6 error signal output*1
27	EXTEND	OUT	Monitoring RS data communication status with I/O Executing RS-232C command using HOLD input: "L" When RS-232C command using HOLD input is completed: "H"
28	READY	OUT	Output data is being defined: "L"
29	START	OUT	Only during CEL1 data output: "L"
30	NORMAL	OUT	Abnormal state: "H" (OR operation of NOM for all CELs)
31	P.SET	IN	Presets the specified CELs.
32	OUTCEL	IN	Sets to output CEL / calculation method specified by SET1 through SET3 when OUTCEL ON is input.
33	SET1	IN	

## 5 External Input/Output Function

No.	Name	I/O	Functions
34	SET2	IN	Sets to output CEL / calculation method specified by SET1 through SET3 when OUTCEL ON is input.
35	SET3	IN	
36	HOLD	IN	Display is held during input. Cancels errors when this signal is raised. Origin re-detection only for EV-16Z (When parameter no. 42 is set to set value 1.)

\*1 "L" when counting is possible.

- Tips**
- For the output of No. 3 through No. 26, the logic can be inverted by parameter no. 21 (output logic of I/O).
  - Inputs of No. 31 through No. 36 are valid for "L".
  - "I/O" refers to the first letters of "Input/Output" respectively. Refer to the input circuit for "IN", and the output circuit for "OUT".

### ● CEL specification method at P.SET

For the setting procedure, see  "■ External Preset" (page 64).

SET3	SET2	SET1	Specified CEL
0	0	0	All CELs
0	0	1	CEL1
0	1	0	CEL2
0	1	1	CEL3
1	0	0	CEL4
1	0	1	CEL5
1	1	0	CEL6
1	1	1	Cannot be specified.

**Tips** 0: "H", 1: "L"

### ■ BCD output

Outputs the data of the CEL specified by the CEL specification in BCD format (6 digits).

- Tips**
- To enable this function, select the following parameter.  
Parameter no. 22 (I/O function mode): Set value 0 (Normal mode)  
Parameter no. 23 (output content from the I/O connector): Set value 2 (BCD output)
  - For details about the timing chart, see  "5.3.6 Timing Chart" (page 61).

## 5 External Input/Output Function

### ● Pin assignment

No.	Name	I/O	Functions	
1	COM	—	Common terminal of I/O circuit (internally connected to GND)	
2	COM	—		
3	1×10 <sup>0</sup>	OUT	BCD output data	
4	2×10 <sup>0</sup>	OUT		
5	4×10 <sup>0</sup>	OUT		
6	8×10 <sup>0</sup>	OUT		
7	1×10 <sup>1</sup>	OUT		
8	2×10 <sup>1</sup>	OUT		
9	4×10 <sup>1</sup>	OUT		
10	8×10 <sup>1</sup>	OUT		
11	1×10 <sup>2</sup>	OUT		
12	2×10 <sup>2</sup>	OUT		
13	4×10 <sup>2</sup>	OUT		
14	8×10 <sup>2</sup>	OUT		
15	1×10 <sup>3</sup>	OUT		
16	2×10 <sup>3</sup>	OUT		
17	4×10 <sup>3</sup>	OUT		
18	8×10 <sup>3</sup>	OUT		
19	1×10 <sup>4</sup>	OUT		
20	2×10 <sup>4</sup>	OUT		
21	4×10 <sup>4</sup>	OUT		
22	8×10 <sup>4</sup>	OUT		
23	1×10 <sup>5</sup>	OUT		
24	2×10 <sup>5</sup>	OUT		
25	4×10 <sup>5</sup>	OUT		
26	8×10 <sup>5</sup>	OUT		BCD output data
27	SIGN	OUT		Sign of the counter value (when +: "H", when -: "L")
28	READY	OUT	Output data is being defined: "L"	
29	START	OUT	Only during CEL1 data output: "L"	
30	NORMAL	OUT	Abnormal state: "H"	
31	P.SET	IN	Presets the specified CELs.	

## 5 External Input/Output Function

No.	Name	I/O	Functions
32	OUTCEL	IN	Sets to output CEL / calculation method specified by SET1 through SET3 when OUTCEL ON is input. <ul style="list-style-type: none"> <li>• In Normal / High-speed mode: CEL specification</li> <li>• In Calculation mode: calculation method specification</li> </ul>
33	SET1	IN	
34	SET2	IN	
35	SET3	IN	
36	HOLD	IN	Display is held during input. Cancels errors when this signal is raised. Origin re-detection only for EV-16Z (When parameter no. 42 is set to set value 1.)

- Tips**
- For the output of No. 3 through No. 26, the logic can be inverted by parameter no. 21 (output logic of I/O).
  - Inputs of No. 31 through No. 36 are valid for "L".
  - "I/O" refers to the first letters of "Input/Output" respectively. Refer to the input circuit for "IN", and the output circuit for "OUT".

### ● Output CEL specification method

For the setting procedure, see  "● Output CEL specification / calculation method specification" (page 65).

SET3	SET2	SET1	Specified CEL
0	0	0	Time-division BCD output of all CEL data (setting at power-on)
0	0	1	BCD output of CEL1 data
0	1	0	BCD output of CEL2 data
0	1	1	BCD output of CEL3 data
1	0	0	BCD output of CEL4 data
1	0	1	BCD output of CEL5 data
1	1	0	BCD output of CEL6 data
1	1	1	Cannot be specified.

**Tips** 0: "H", 1: "L"



## 5 External Input/Output Function

### ■ Segment output

Outputs the data of the CEL specified by the output CEL specification in segment format.

Segment output is a function to equally divide the preset measurement range into 21 segments and output measured values judged in 21 phases.

Segment output terminals are 21 terminals from -L10 through +L10.

#### Tips

- To enable this function, select the following parameter.  
Parameter no. 22 (I/O function mode): Set value 0 (Normal mode)  
Parameter no. 23 (output content from the I/O connector): Set value 1 (segment output)
- For details about the timing chart, see  "5.3.6 Timing Chart" (page 61).

### ● Pin assignment

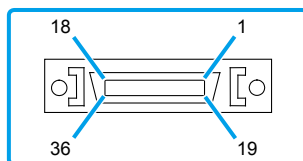

No.	Name	I/O	Functions
1	COM	—	Common terminal of I/O circuit (internally connected to GND)
2	COM	—	
3	-OV	OUT	Outputs when the measured value exceeds the measurement range to the minus side.
4	-L10	OUT	Segment output data
5	-L9	OUT	
6	-L8	OUT	
7	-L7	OUT	
8	-L6	OUT	
9	-L5	OUT	
10	-L4	OUT	
11	-L3	OUT	
12	-L2	OUT	
13	-L1	OUT	
14	L0	OUT	
15	+L1	OUT	

## 5 External Input/Output Function

No.	Name	I/O	Functions
16	+L2	OUT	Segment output data
17	+L3	OUT	
18	+L4	OUT	
19	+L5	OUT	
20	+L6	OUT	
21	+L7	OUT	
22	+L8	OUT	
23	+L9	OUT	
24	+L10	OUT	
25	+OV	OUT	
26	NOM	OUT	Abnormal state: "H"
27	EXTEND	OUT	Monitoring RS data communication status with I/O Executing RS-232C command using HOLD input: "L" When RS-232C command using HOLD input is completed: "H"
28	READY	OUT	Output data is being defined: "L"
29	START	OUT	Only during CEL1 data output: "L"
30	NORMAL	OUT	Abnormal state: "H"
31	P.SET	IN	Presets the specified CELs.
32	OUTCEL	IN	Sets to output CEL / calculation method specified by SET1 through SET3 when OUTCEL ON is input. <ul style="list-style-type: none"> <li>• In Normal / High-speed mode: CEL specification</li> <li>• In Calculation mode: calculation method specification</li> </ul>
33	SET1	IN	
34	SET2	IN	
35	SET3	IN	
36	HOLD	IN	Display is held during input. Cancels errors when this signal is raised. Origin re-detection only for EV-16Z (When parameter no. 42 is set to set value 1.)

- Tips**
- For the output of No. 3 through No. 26, the logic can be inverted by parameter no. 21 (output logic of I/O).
  - Inputs of No. 31 through No. 36 are valid for "L".
  - "I/O" refers to the first letters of "Input/Output" respectively. Refer to the input circuit for "IN", and the output circuit for "OUT".

## 5 External Input/Output Function

### ● Output CEL specification method

For the setting procedure, see  "● Output CEL specification / calculation method specification" (page 65).

SET3	SET2	SET1	Specified CEL
0	0	0	Time-division segment output of all CEL data (setting at power-on)
0	0	1	Segment output of CEL1 data
0	1	0	Segment output of CEL2 data
0	1	1	Segment output of CEL3 data
1	0	0	Segment output of CEL4 data
1	0	1	Segment output of CEL5 data
1	1	0	Segment output of CEL6 data
1	1	1	Cannot be specified.

**Tips** 0: "H", 1: "L"

### ● List of measurement ranges

By inputting SET1 through SET3, the measurement range can be specified / changed.

For the setting procedure, see  "● Output CEL specification / calculation method specification" (page 65).

**When the peak mode is the current value, MAX, MIN:**

SET1	SET2	SET3	Measurement range (mm) / range resolution (mm)			
			10 $\mu$ m Linear Gage	5 $\mu$ m Linear Gage	1 $\mu$ m Linear Gage	0.5 $\mu$ m Linear Gage
0	0	0	0 $\pm$ 0.1/0.01	0 $\pm$ 0.05/0.005	0 $\pm$ 0.01/0.001	0 $\pm$ 0.005/0.0005
0	0	1	0 $\pm$ 0.2/0.02	0 $\pm$ 0.1/0.01	0 $\pm$ 0.02/0.002	0 $\pm$ 0.01/0.001
0	1	0	0 $\pm$ 0.5/0.05	0 $\pm$ 0.25/0.025	0 $\pm$ 0.05/0.005	0 $\pm$ 0.025/0.0025
0	1	1	0 $\pm$ 1/0.1	0 $\pm$ 0.5/0.05	0 $\pm$ 0.1/0.01	0 $\pm$ 0.05/0.005
1	0	0	0 $\pm$ 2/0.2	0 $\pm$ 1/0.1	0 $\pm$ 0.2/0.02	0 $\pm$ 0.1/0.01
1	0	1	0 $\pm$ 5/0.5	0 $\pm$ 2.5/0.25	0 $\pm$ 0.5/0.05	0 $\pm$ 0.25/0.025
1	1	0	0 $\pm$ 10/1	0 $\pm$ 5/0.5	0 $\pm$ 1/0.1	0 $\pm$ 0.5/0.05
1	1	1	0 $\pm$ 20/2	0 $\pm$ 10/1	0 $\pm$ 2/0.2	0 $\pm$ 1/0.1

## 5 External Input/Output Function

### When the peak mode is TIR:

SET1	SET2	SET3	Measurement range (mm) / range resolution (mm)			
			10 $\mu$ m Linear Gage	5 $\mu$ m Linear Gage	1 $\mu$ m Linear Gage	0.5 $\mu$ m Linear Gage
0	0	0	0-0.2/0.01	0-0.1/0.005	0-0.02/0.001	0-0.01/0.0005
0	0	1	0-0.4/0.02	0-0.2/0.01	0-0.04/0.002	0-0.02/0.001
0	1	0	0-1.0/0.05	0-0.5/0.025	0-0.1/0.005	0-0.05/0.0025
0	1	1	0-2/0.1	0-1/0.05	0-0.2/0.01	0-0.1/0.005
1	0	0	0-4/0.2	0-2/0.1	0-0.4/0.02	0-0.2/0.01
1	0	1	0-10/0.5	0-5/0.25	0-1/0.05	0-0.5/0.025
1	1	0	0-20/1	0-10/0.5	0.1(0)-2/0.1	0-1/0.05
1	1	1	0-40/2	0-20/1	0-4/0.2	0-2/0.1

**Tips** The range resolution (range of one segment) is the value obtained by dividing the measurement range into 20 equal parts.

For example, if the measurement range is  $0 \pm 0.1$  mm, the range resolution is 0.01 mm.

- The relationship between the measured value and the output terminal  
In segment output, the output terminal (relevant terminal Ln) corresponding to the measured value will be ON.

The n of the relevant terminal Ln ( $-10 \leq n \leq +10$  \* n is an integer) can be calculated by the following formula. (When n is in the range of -10 through -1, the terminal indicates -L10 through -L1.)

Peak mode	n calculation formula
Current value MAX MIN	If the measured value is +: $n = \text{INT} ((\text{measured value} + 1/2 \text{ range resolution}) / \text{range resolution})$ If the measured value is -: $n = \text{INT} ((\text{measured value} - 1/2 \text{ range resolution}) / \text{range resolution})$
TIR	$n = -10 + \text{INT} (\text{measured value} / \text{range resolution})$

- Output pattern

Depending on the type of peak mode, the output pattern of the segment differs.

Peak mode	Output pattern
Current value	Only relevant terminal Ln: ON
MAX	-L10 through relevant terminal Ln: ON
MIN	Relevant terminal Ln through +L10: ON
TIR	Only relevant terminal Ln: ON

## 5 External Input/Output Function

**NOTICE** When the range is exceeded, -L10 through L10 all will be OFF.

- +0 V: Measured value exceeds the measurement range to the + side
- -0 V: Measured value exceeds the measurement range to the - side

**Tips** Difference in display between [CH01=A] and [CH01\_A]

When [DISP] is pressed to switch the display, the CEL with "=" indicates that I/O output is in progress, and the CEL with "\_" indicates that I/O output is not in progress.

### 5.3.3 Output Function (Calculation Mode)

The calculation result specified by SET1 through SET3 is output using the CEL specified by parameter number 17 (applicable CEL used in calculation function).

#### Setting calculation method

For the detailed procedure, see  "● Output CEL specification / calculation method specification" (page 65).

SET3	SET2	SET1	Calculation method
0	0	0	No calculation (setting at power-on)
0	0	1	Total value of CEL data with designated calculation axis
0	1	0	Average value of CEL data with designated calculation axis
0	1	1	Maximum value of CEL data with designated calculation axis
1	0	0	Minimum value of CEL data with designated calculation axis
1	0	1	Maximum value - Minimum value of CEL data with designated calculation axis
1	1	0	Cannot be specified.
1	1	1	Cannot be specified.

**Tips** 0: "H", 1: "L"

#### ■ Tolerance judgment result output

- The tolerance judgment result of the calculation result is output from CEL6.
- When there is no calculation, the tolerance judgment result of the counter value of CEL6 is output.
- For tolerance, the tolerance value of CEL6 is applied.

- Tips**
- To enable this function, select the following parameter.  
Parameter no. 22 (I/O function mode): Set value 1 (Calculation mode)  
Parameter no. 23 (output content from the I/O connector): Set value 0 (tolerance judgment result output)  
Parameter no. 17 (applicable CEL used in calculation function): Set value 0 to Set value 3
  - For details about the timing chart, see  "5.3.6 Timing Chart" (page 61).
  - Display of the D-EV at Calculation mode setting  
When the display is switched by pressing [DISP], the following are displayed in order after normal display (CH01 through CH06, all axes tolerance judgment bar display) each time [DISP] is pressed.  
[CL01\_1]→Total value→[CL02\_2]→Average value→[CL03\_2]→Maximum value→[CL04\_4]→Minimum value→[CL05\_5]→Maximum value - Minimum value  
When RS LINK is connected, the second EV Counter displays the following in order.  
[CL07\_1]→Total value→[CL08\_2]→Average value→[CL09\_3]→Maximum value→[CL10\_4]→Minimum value→[CL11\_5]→Maximum value - Minimum value\* In Calculation mode, key operations other than [DISP] are disabled.
  - Difference in display between [CH06=F] and [CH06\_F]  
When the setting of SET3 through SET1 is other than 000 (calculation item is specified) and CH06 is specified by pressing [DISP], after [CH06\_F], the measured value is displayed. In other words, [ \_ ] means that the tolerance judgment is not output to the measured value of CH06, and the tolerance judgment is output to the calculation result.  
On the other hand, when SET=000, the tolerance judgment is output to the measured value of CH06, and the measured value is displayed after [CH06=F].

### ■ BCD output

- Outputs the calculation result specified by the SET3 through SET1 input in BCD format.
- When SET3 through SET1 is "000", all CEL data is output by time-division.

- Tips**
- To enable this function, select the following parameter.  
Parameter no. 22 (I/O function mode): Set value 1 (Calculation mode)  
Parameter no. 23 (output content from the I/O connector): Set value 2 (BCD output)  
Parameter no. 17 (applicable CEL used in calculation function): Set value 0 through Set value 3
  - For details about the timing chart, see  "5.3.6 Timing Chart" (page 61).

### ■ Segment output

- Outputs the calculation result specified by the SET3 through SET1 input in segment format.
- When SET3 through SET1 is "000", all CEL data is output by time-division.

- Tips**
- To enable this function, select the following parameter.  
Parameter no. 22 (I/O function mode): Set value 1 (Calculation mode)  
Parameter no. 23 (output content from the I/O connector): Set value 1 (segment output)  
Parameter no. 17 (applicable CEL used in calculation function): Set value 0 through Set value 3
  - For details about the timing chart, see  "5.3.6 Timing Chart" (page 61).

### 5.3.4 Output Function (High-Speed Mode)

Outputs the data of the CEL specified by the output CEL specification at high speed.

The data output interval in High-speed mode is 5 ms (in Normal mode: 30 ms).

#### Output CEL specification method

For the detailed procedure, see  "● Output CEL specification / calculation method specification" (page 65).

SET3	SET2	SET1	Calculation method
0	0	0	Time-division output of all CEL data (same as Normal mode. setting at power-on)
0	0	1	High speed output of CEL1 data*1
0	1	0	High speed output of CEL2 data*1
0	1	1	High-speed output of CEL3 data*1
1	0	0	High-speed output of CEL4 data*1
1	0	1	High-speed output of CEL5 data*1
1	1	0	High-speed output of CEL6 data*1
1	1	1	Cannot be specified.

\*1 Other CEL output functions stop.

**Tips** 0: "H", 1: "L"

### NOTICE

Operation in non-driven state

- Preset, peak clear, and Zero setting (D-EV, I/O, RS-232 C) to CELs other than the CELs specified by SET1 through SET3 are suspended and operate only when the CEL is specified.
- Even in the all axes tolerance judgment bar display, the bar will not move except for the specified CELs.
- The RS-232C output of CELs other than the CELs specified by SET1 through SET3 outputs the immediately preceding data (data when in the non-driven state).
- If an output CEL other than the CEL displayed by the D-EV is specified, the display will be held.
- When a key is operated with the D-EV, I/O outputs all CEL data by time-division.

### ■ Tolerance judgment result output

Outputs the tolerance judgment result of the CEL specified by the output CEL specification at high speed.

#### Tips

- To enable this function, select the following parameter.  
Parameter no. 22 (I/O function mode): Set value 2 (High-speed mode)  
Parameter no. 23 (output content from the I/O connector): Set value 0 (tolerance judgment result output)
- For details about the timing chart, see  "5.3.6 Timing Chart" (page 61).

### ■ BCD output

Outputs the data of the CEL specified by the output CEL specification in BCD format.

#### Tips

- To enable this function, select the following parameter.  
Parameter no. 22 (I/O function mode): Set value 2 (High-speed mode)  
Parameter no. 23 (output content from the I/O connector): Set value 2 (BCD output)
- For details about the timing chart, see  "5.3.6 Timing Chart" (page 61).



## 5 External Input/Output Function

### ■ Segment output

Outputs the data of the CEL specified by the output CEL specification in segment format at high speed.

- Tips**
- To enable this function, select the following parameter.  
Parameter no. 22 (I/O function mode): Set value 2 (High-speed mode)  
Parameter no. 23 (output content from the I/O connector): Set value 1 (segment output)
  - For details about the timing chart, see  "5.3.6 Timing Chart" (page 61).

### 5.3.5 Input Function

External signal input can chiefly perform the following functions.

- Output CEL specification
- Calculation method specification
- Remote control of Zero Setting, Preset, Tolerance Value
- Counter value HOLD
- Clearing peak value, canceling errors

For details about the timing chart, see  "5.3.6 Timing Chart" (page 61).

### 5.3.6 Timing Chart

#### ■ Power ON characteristics

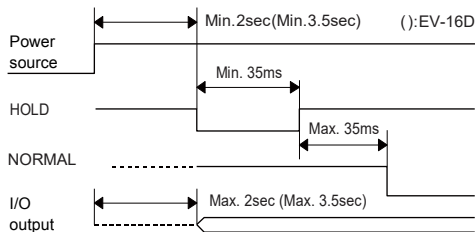

- Tips** When connected to RS LINK, the Counter that powered on last is the reference.

## 5 External Input/Output Function

### ■ Tolerance judgment result output time

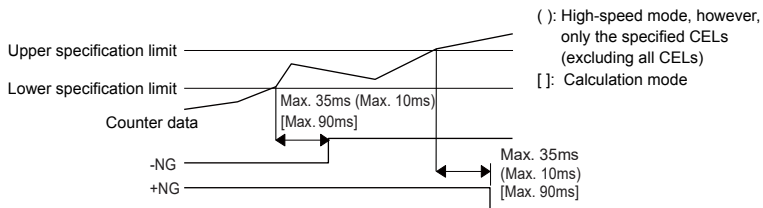

- Tips**
- The output of each CEL is not simultaneous.
  - For EV-16D, the length of time until the tolerance judgment is output after the counter data enters in the Specification range depends on the connected equipment, such as the Linear Gage.

## 5 External Input/Output Function

### ■ Data output

There are two methods of data output, command mode and interval mode, and they can be selected by parameter number 20 (output mode from the I/O connector).

**Tips** When using in High-speed mode or all CEL output, use a device with an input response time of 1 ms or less.

### ● Command mode (all CEL output)

Data of all CELs (specified by SET1 through SET3) is output by synchronous control via HOLD and READY.

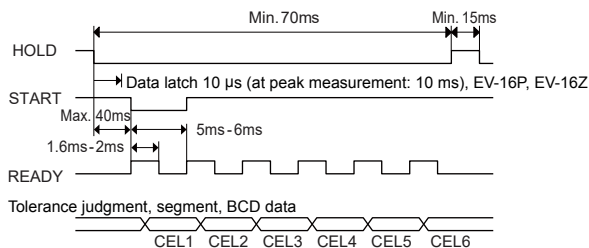

**Tips** During HOLD input, the D-EV UNIT indicator will blink.

### ● Command mode (individual CEL output)

Data of individual CEL (specified by SET1 through SET3) is output by synchronous control via HOLD and READY.

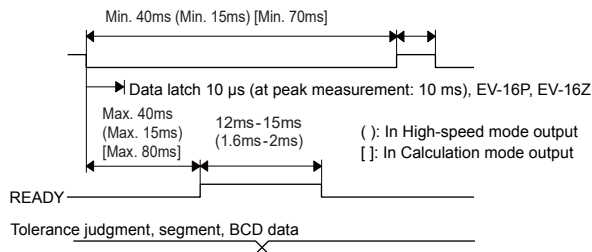

## 5 External Input/Output Function

### ● Interval mode (all CEL output)

Data of all CELs (specified by SET 1 through SET3) is continuously output at the internal timing of the counter.

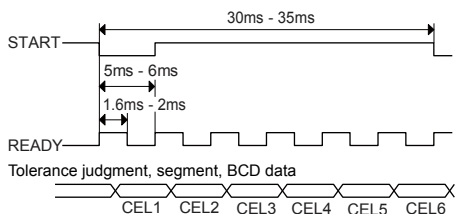

### ● Interval mode (individual CEL output)

Data of individual CEL (specified by SET 1 through SET3) is continuously output at the internal timing of the counter.

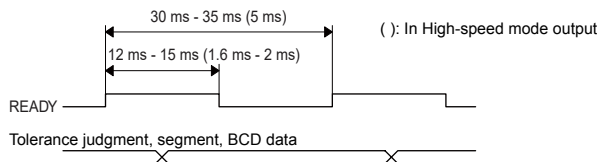

### ■ External Preset

Presets the current value of the CEL specified by SET1 through SET3.

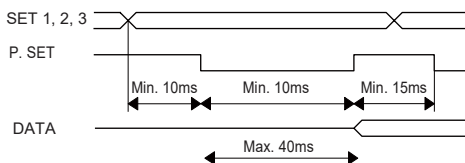

**Tips** The peak value will be cleared when Preset is executed.  
(MAX=MIN=current value, TIR=0)

## 5 External Input/Output Function

### ● Output CEL specification / calculation method specification

In Normal mode and High-speed mode, set the CEL specified by SET1 through SET3 to the data output CEL.

In Calculation mode, specify the calculation method with SET1 through SET3.

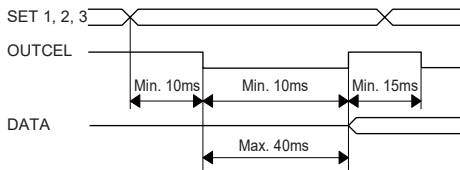

**Tips** SET3 to SET1 input at segment output  
Normally, it operates as range specification data, but for OUTCEL input, it specifies output CEL. For details, see "5.3.3 Output Function (Calculation Mode)" (page 57), "5.3.4 Output Function (High-Speed Mode)" (page 59).

### ■ Peak clear

Clears the peak value. (MAX=MIN=current value, TIR=0)

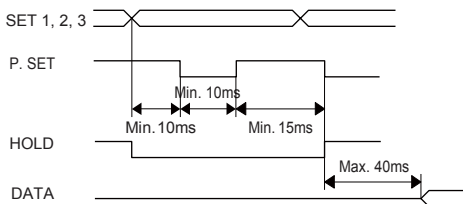

**Tips**

- Clears the peak value in Peak mode. (Preset is performed when it is the current value.)
- For EV-16D, the data update time depends on the type of Linear Gage connected. In addition, multiple cycles of the same data may be output.

## 5 External Input/Output Function

---

### ■ HOLD

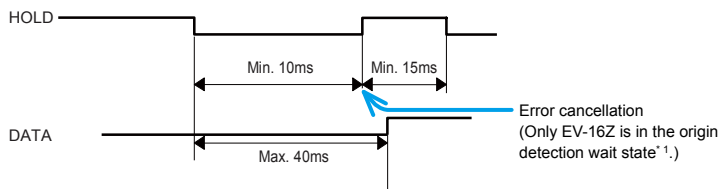

\* 1 When parameter number 42 (origin re-detection of Linear Gage with origin mark) is set to set value 1 (valid).

## 6 Parameter Setting Method (Setting with the EV Counter Main Body)

To use the EV Counter, it is necessary to set the parameters. Parameter settings can be done more easily by using the D-EV.

For details about parameter settings using the D-EV, see  "3.1 Parameter Setting Method" (page 12).

**Tips** For the EV-16Z, the settings related to the origin cannot be changed with the EV Counter main body. The D-EV is required to change the settings related to the origin.

### NOTICE

- When applying settings with the EV Counter main body, the resolution cannot be set to 0.1  $\mu\text{m}$ . When applying settings, use the D-EV.
- When changing to parameter 41, 42, 43, only the D-EV can be set.
- For the EV-16P and the EV-16Z, when connecting a Linear Gage with other than 1  $\mu\text{m}$  resolution, it is necessary to change the setting to the resolution of the Linear Gage.
- For EV-16D, it is necessary to set the gage type (INC, ABS, etc.).
- If (Designation of available axis > Number of gages) is set, an error display / output (Error40) occurs.  
If (Designation of available axis < Number of gages) is set, gages other than those specified will be ignored.  
For details, see  "7.2.1 List of Error Codes" (page 76).

### 6.1 Parameter Mode ON

Parameter settings can be changed by turning Parameter mode ON.

**1** Press and hold the [DATA] button, and then press the [LOAD] button.

» Parameter mode turns ON.

**2** Start parameter settings.

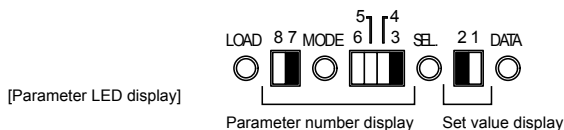

**Tips** Indication:  LED on,  LED off.

## 6.2 Setting Parameters

- 1 Select the parameter of which you want to change the settings by referring to  "6.4 List of Parameters" (page 70).

**Tips** Pressing the MODE button switches between the LED no. 8 and no. 7, and pressing the SEL button switches between the LED no. 6, no. 5, no. 4, and no. 3.

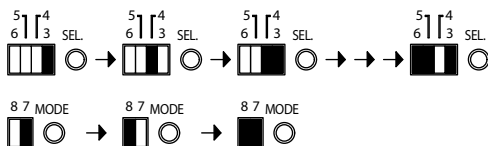

- 2 Press the [DATA] button to select the parameter value.

» Pressing the [DATA] button switches [Parameter LED display] between the LED display no. 1 and no. 2.

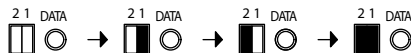

- 3 Press the [LOAD] button to fix the selected parameter value.

» Automatically moves to the next parameter.

**NOTICE** | Changes will not be reflected unless the fixing work is performed.

- 4 Repeat steps 1 through 3 to set necessary parameters.

For details, see  "6.4 List of Parameters" (page 70).



## 6.3 Parameter Mode OFF

**1** Press and hold the [DATA] button, and then press the [LOAD] button to turn OFF parameter mode.

- » The Counter will return to the counter value display. [Parameter LED display]
- » Only EV-16Z returns to the counter value display after passing the origin.

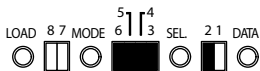

### NOTICE

- When Parameter mode is OFF, while pressing and holding down the [MODE] button, when you press the [LOAD] button for 1 second or more, all parameters will return to the settings at shipment.
- During parameter settings, the D-EV key operation, RS-232 output, and external signal input are stopped.

## 6.4 List of Parameters

\*Settings at shipment

Parameter name	LED						Setting contents	LED	
	8	7	6	5	4	3		2	1
In the case of the EV-16P, the EV-16Z									
Resolution of INPUT A <sup>1</sup>	<input type="checkbox"/>	<input checked="" type="checkbox"/>	<input type="checkbox"/>	<input type="checkbox"/>	<input type="checkbox"/>	<input checked="" type="checkbox"/>	10 μm	<input type="checkbox"/>	<input type="checkbox"/>
Resolution of INPUT B <sup>1</sup>	<input type="checkbox"/>	<input checked="" type="checkbox"/>	<input type="checkbox"/>	<input type="checkbox"/>	<input type="checkbox"/>	<input checked="" type="checkbox"/>	5 μm	<input type="checkbox"/>	<input checked="" type="checkbox"/>
Resolution of INPUT C <sup>1</sup>	<input type="checkbox"/>	<input checked="" type="checkbox"/>	<input type="checkbox"/>	<input type="checkbox"/>	<input type="checkbox"/>	<input checked="" type="checkbox"/>	1 μm*	<input checked="" type="checkbox"/>	<input type="checkbox"/>
Resolution of INPUT D <sup>1</sup>	<input type="checkbox"/>	<input checked="" type="checkbox"/>	<input type="checkbox"/>	<input type="checkbox"/>	<input type="checkbox"/>	<input type="checkbox"/>	0.5 μm	<input checked="" type="checkbox"/>	<input checked="" type="checkbox"/>
Resolution of INPUT E <sup>1</sup>	<input type="checkbox"/>	<input checked="" type="checkbox"/>	<input type="checkbox"/>	<input type="checkbox"/>	<input type="checkbox"/>	<input checked="" type="checkbox"/>			
Resolution of INPUT F <sup>1</sup>	<input type="checkbox"/>	<input checked="" type="checkbox"/>	<input type="checkbox"/>	<input type="checkbox"/>	<input type="checkbox"/>	<input type="checkbox"/>			
In the case of the EV-16D									
INPUT A gage type	<input type="checkbox"/>	<input checked="" type="checkbox"/>	<input type="checkbox"/>	<input type="checkbox"/>	<input type="checkbox"/>	<input checked="" type="checkbox"/>	INC (LGS series)		
INPUT B gage type	<input type="checkbox"/>	<input checked="" type="checkbox"/>	<input type="checkbox"/>	<input type="checkbox"/>	<input type="checkbox"/>	<input checked="" type="checkbox"/>		<input type="checkbox"/>	<input type="checkbox"/>
INPUT C gage type	<input type="checkbox"/>	<input checked="" type="checkbox"/>	<input type="checkbox"/>	<input type="checkbox"/>	<input type="checkbox"/>	<input checked="" type="checkbox"/>	ABS (LGD series)*		
INPUT D gage type	<input type="checkbox"/>	<input checked="" type="checkbox"/>	<input type="checkbox"/>	<input type="checkbox"/>	<input type="checkbox"/>	<input type="checkbox"/>		<input type="checkbox"/>	<input checked="" type="checkbox"/>
INPUT E gage type	<input type="checkbox"/>	<input checked="" type="checkbox"/>	<input type="checkbox"/>	<input type="checkbox"/>	<input type="checkbox"/>	<input checked="" type="checkbox"/>	ABS ORG	<input checked="" type="checkbox"/>	<input type="checkbox"/>
INPUT F gage type	<input type="checkbox"/>	<input checked="" type="checkbox"/>	<input type="checkbox"/>	<input type="checkbox"/>	<input type="checkbox"/>	<input type="checkbox"/>			
Counter direction when INPUT A spindle is pushed in	<input checked="" type="checkbox"/>	<input type="checkbox"/>	<input type="checkbox"/>	<input type="checkbox"/>	<input type="checkbox"/>	<input checked="" type="checkbox"/>	Count in the + direction *	<input type="checkbox"/>	<input type="checkbox"/>
Counter direction when INPUT B spindle is pushed in	<input checked="" type="checkbox"/>	<input type="checkbox"/>	<input type="checkbox"/>	<input type="checkbox"/>	<input type="checkbox"/>	<input checked="" type="checkbox"/>	Count in the - direction	<input type="checkbox"/>	<input checked="" type="checkbox"/>
Counter direction when INPUT C spindle is pushed in	<input checked="" type="checkbox"/>	<input type="checkbox"/>	<input type="checkbox"/>	<input type="checkbox"/>	<input checked="" type="checkbox"/>	<input checked="" type="checkbox"/>	When pushing in the spindle		
Counter direction when INPUT D spindle is pushed in	<input checked="" type="checkbox"/>	<input type="checkbox"/>	<input type="checkbox"/>	<input checked="" type="checkbox"/>	<input type="checkbox"/>	<input type="checkbox"/>			
Counter direction when INPUT E spindle is pushed in	<input checked="" type="checkbox"/>	<input type="checkbox"/>	<input type="checkbox"/>	<input checked="" type="checkbox"/>	<input type="checkbox"/>	<input checked="" type="checkbox"/>			
Counter direction when INPUT F spindle is pushed in	<input checked="" type="checkbox"/>	<input type="checkbox"/>	<input type="checkbox"/>	<input checked="" type="checkbox"/>	<input checked="" type="checkbox"/>	<input type="checkbox"/>			
Designation of available axis 1 <sup>2,3</sup>	<input checked="" type="checkbox"/>	<input checked="" type="checkbox"/>	<input type="checkbox"/>	<input type="checkbox"/>	<input type="checkbox"/>	<input checked="" type="checkbox"/>	Axis designation 2 is valid.*	<input type="checkbox"/>	<input type="checkbox"/>
							Connection of one axis	<input type="checkbox"/>	<input checked="" type="checkbox"/>
							Connection of two axes	<input checked="" type="checkbox"/>	<input type="checkbox"/>
							Connection of three axes	<input checked="" type="checkbox"/>	<input checked="" type="checkbox"/>
Designation of available axis 2 <sup>2,3</sup>	<input checked="" type="checkbox"/>	<input checked="" type="checkbox"/>	<input type="checkbox"/>	<input type="checkbox"/>	<input checked="" type="checkbox"/>	<input type="checkbox"/>	Axis designation 1 is valid.	<input type="checkbox"/>	<input type="checkbox"/>
							Connection of four axes	<input type="checkbox"/>	<input checked="" type="checkbox"/>
							Connection of five axes	<input checked="" type="checkbox"/>	<input type="checkbox"/>
							Connection of six axes*	<input checked="" type="checkbox"/>	<input checked="" type="checkbox"/>

## 6 Parameter Setting Method (Setting with the EV Counter Main Body)

\*Settings at shipment

Parameter name	LED						Setting contents	LED	
	8	7	6	5	4	3		2	1
Display at startup	■	■	□	□	■	■	Stand-by*	□	□
	■	■	■	■	■	■	Counter execution	□	■
Display unit (mm, E) <sup>11, 14</sup>	■	■	□	■	□	□	mm *	□	□
	■	■	■	■	■	■	E (=1/25.4mm)	□	■
Applicable CEL used in calculation function <sup>5</sup>	■	■	□	■	□	■	CEL1, 2*	□	□
	■	■	■	■	■	■	CEL1, 2, 3	□	■
	■	■	■	■	■	■	CEL1, 2, 3, 4	■	□
	■	■	■	■	■	■	All CELs <sup>6</sup>	■	■
Output mode from I/O connector <sup>7</sup>	■	■	□	■	■	□	Command	□	□
	■	■	■	■	■	■	Interval*	□	■
I/O output logic (positive logic H, negative logic L) <sup>8</sup>	■	■	□	■	■	■	Output terminal is H.*	□	□
	■	■	■	■	■	■	Output terminal is L.	□	■
I/O function mode <sup>7</sup>	■	■	■	□	□	□	Normal mode*	□	□
	■	■	■	■	■	■	Calculation mode	□	■
	■	■	■	■	■	■	High-speed mode	■	□
Output content from the I/O connector <sup>7</sup>	■	■	■	□	□	■	Tolerance judgment output*	□	□
	■	■	■	■	■	■	Segment output	□	■
	■	■	■	■	■	■	BCD output	■	□
RS-232C data transfer speed <sup>9, 10</sup>	■	■	■	□	■	□	4800bps	□	□
	■	■	■	■	■	■	9600bps *	□	■
	■	■	■	■	■	■	19200bps	■	□
RS-232C parity check <sup>8, 9</sup>	■	■	■	□	■	■	None	□	□
	■	■	■	■	■	■	Odd number	□	■
	■	■	■	■	■	■	Even number*	■	□
RS-232C data bit <sup>9, 10</sup>	■	■	■	■	□	□	7bit *	□	□
	■	■	■	■	■	■	8bit	□	■
RS-232C output trigger <sup>10</sup>	■	■	■	■	□	■	HOLD *	□	□
	■	■	■	■	■	■	RS-232C output <sup>11</sup>	□	■



## 6 Parameter Setting Method (Setting with the EV Counter Main Body)



---

- \*1 All zero points, the Preset value and tolerance value that had been set will be cleared if the setting is changed.
- \*2 An error occurs if the actual number of connected Linear Gages is different to the parameter settings.
  - Designation of available axis > Number of gages: Displays / outputs [Error40].
  - Designation of available axis < Number of gages: Displays / outputs the gages set by the designation of available axis.
- \*3 It is related to the "Applicable CEL used in calculation function" parameter. For details, see  "3.5.1 Details of the Available Axis Designation Parameters" (page 22).
- \*4 When setting, the UNIT indicator lights in green.
- \*5 Set the CEL to be used in the calculation function. (This function is enabled only when I/O function selection is in Calculation mode.)
- \*6 When all CELs (all CELs with designated available axes) are selected, the CELs used for the calculation are as follows.

Designation of available axis set value	CELs used for calculation
6	1, 2, 3, 4, 5, 6
5	1, 2, 3, 4, 5
4	1, 2, 3, 4
3	1, 2, 3
2 or 1	1, 2

- \*7 For details of this function, see  "5.3 I/O Connector Terminal Function" (page 47).
- \*8 The output logic of the data part differs depending on the I/O type selection result.  
However, the input signal and the NORMAL, READY, START, and EXTEND outputs are logically fixed.

	Tolerance judgment and segment output	BCD output
 <input type="checkbox"/>	L for relevant output terminal, H for others	1=H, 0=L
 <input type="checkbox"/>	H for relevant output terminal, L for others	1=L, 0=H

- \*9 For details about this function, see  "5.1 RS-232C Communication Function" (page 40).
- \*10 Changes to this parameter become valid by turning on the power again.
- \*11 This function outputs data from the RS-232C connector using the HOLD input from the I/O connector.  
  In this case, the RS-232C command becomes invalid.

MEMO

# 7 Troubleshooting

## 7.1 Troubleshooting

When the Counter does not operate as expected, refer to the cause of the trouble and the solutions shown below:

Problem	Cause	Solution
There is no response to the command from the EV Counter.	The RS LINK connection cable is not properly connected.	Check the cable connection.
	The straight specifications RS-232C connecting cable is being used.	Check the RS-232C connecting cable specifications and use the correct specifications cable.
	The communication conditions between the personal computer and the EV Counter does not match.	Check the settings of the communication conditions.
	The cable is not connected to the port specified by the communications port of the personal computer.	On some personal computers, it is necessary to specify the communications port and set whether to use or not to use it. Correctly connect the cable to the specified port.
	The RS-232C communication function is stopped / held while key operation or parameter settings is in progress.	Check the communication status after the key operation and the parameter settings.
The initial setting does not end. (the D-EV keeps [- - - - -] display blinking.)	Remove the cause of the initial setting being unable to end.	Turn on the power to all connected Counters again.
In the middle of turning on the power, the Counter enters the stand-by state. (There is a Counter where the D-EV display changes to [- - - -] display being on.)	The RS LINK connection cable is not properly connected.	Check the cable connection. After checking the cable connection, turn on the power to all of the Counters again.

## 7 Troubleshooting

<b>Problem</b>	<b>Cause</b>	<b>Solution</b>
Commands (Zero setting, Preset, etc.) from the personal computer can be executed, but data cannot be loaded. Or, the process stops while loading.	A command such as Zero setting has not been read.	Check the response output of the Counter with a command such as Zero setting.
	The following command is output before the response output from the Counter.	Check whether the following command is output before the response output from the Counter.
	The number of CHs for RS LINK connection and the number of data loading cases do not match.	Check the number of channels for RS LINK connection and the number of data loading cases.
A command error occurs when the command is sent.	Sending the command in full-width characters, or lowercase letters.	Send the command in half-width characters and uppercase letters.
	A number that is equal to or greater than the number of the connected CHs was specified.	Specify a number within the number of the connected CHs.

## 7.2 Error Messages

### 7.2.1 List of Error Codes

D-EV	EV main body	I/O output				RS output <sup>4</sup>	Cause of error	Cancellation method	Countermeasure
		NORMAL signal	Tolerance <sup>1</sup>	Segment <sup>1</sup>	BCD <sup>1</sup>				
Display / UNIT LED Err10 / On red	Error LED / Parameter LED On amber / No display	H	CEL*_+NG=L CEL*_NG=L CEL*_NOM=H	NOM=H +0V=L -0V=L	FFFF10	Error10	Automatic cancellation	Connect to the specified power supply.	
[----] blinking / Off	Amber blinking / No display	H	CEL*_+NG=H <sup>9</sup> CEL*_NG=H CEL*_NOM=H	NOM=H <sup>9</sup> +0V=H -0V=H	FFFFF <sup>9</sup>	None	Automatic cancellation or re-power supply connection.	Check the RS LINK connection cable connection.	
[----] on / On red	On amber / No display	H	CEL*_+NG=L CEL*_NG=L CEL*_NOM=H	NOM=H +0V=L -0V=L	FFFF15	Error15	P. SET key CS00 command (RS) HOLD input (I/O)	In the case of power interruption, it is necessary to review the power.	
Err 20 <sup>2</sup> / On red	On amber / On <sup>6</sup>	H	CEL*_+NG=L CEL*_NG=L CEL*_NOM=H	NOM=H <sup>2</sup>	FFFF20 <sup>2</sup>	Error20	After CEL specification with DISP key, P. SET key (RS) CS** command HOLD input (I/O)	Review measurement conditions.	
Err 30 <sup>2</sup> / On red	On amber / On <sup>6</sup>	H	CEL*_+NG=L CEL*_NG=L CEL*_NOM=H	NOM=H <sup>2</sup>	FFFF30 <sup>2</sup>	Error30	Same as above	Change of Preset value	
Err 40 <sup>2</sup> / On red	On amber / On <sup>6</sup>	H	CEL*_+NG=L CEL*_NG=L CEL*_NOM=H	NOM=H <sup>2</sup>	FFFF40 <sup>2</sup>	Error40	Same as above <sup>10</sup>	Check the gage connection.	
Counter value / Off	No display	L	Counter value status	Counter value status	Counter value status	Error50	Automatic cancellation	Check the RS communication conditions.	



## 7 Troubleshooting

D-EV	EV main body	I/O output				RS output <sup>4</sup>	Cause of error	Cancellation method	Countermeasure
		NORMAL signal	Tolerance <sup>1</sup>	Segment <sup>1</sup>	BCD <sup>1</sup>				
Display / UNIT LED	Error LED / Parameter LED								
Counter value / Off	No display	L	Counter value status	Counter value status	Counter value status	Error52	RS command malfunction	Automatic cancellation	Review RS command.
Err55 / On red	On red / No display	H	CEL*+_NG=L CEL*+_NG=L CEL*_NOM=H	NOM=H +OV=L -OV=L	FFFF55	None	RS LINK malfunction	Re-power supply P.SET key CS** command (RS) HOLD input (I/O)	Check the unit's connection status, power supply, etc.
Err 90 <sup>3</sup> / Off	No display	L	Counter value status	Counter value status	Counter value status	Error90 <sup>5</sup>	Tolerance value setting error	P.SET key	Re-input tolerance value.
F**** / Off	No display	L	Counter value status	Counter value status	F****	Normal output	The counter value is 6 digits or more.	Automatic cancellation	Not required <sup>3</sup>
Err70 / Off	No display	L	CEL*+_NG=L CEL*+_NG=L CEL*_NOM=H	NOM=H +OV=L -OV=L	FFFF70	Error70	Gage resolution with designated calculation axis disagrees. Calculation result overflows.	Automatic cancellation	Replace with gage with matching resolution.
All decimal points blinking	No display	L	Counter value status	Counter value status	Counter value status	None	Origin undetected	Automatic cancellation	Pass through the origin.

### NOTICE

If an error occurs while you are setting parameters, the Preset value, or the tolerance value, the error will be displayed after you return to a state where counting is possible. However, the error signal will be output immediately to any external output. In High-speed mode, an error is output only when an error occurrence CH is specified.

For the EV-16Z only, errors are canceled by re-entering the origin after eliminating the error cause.

- \*1 Operations when the I/O output logic parameter is at initial setting
- \*2 An error is output and displayed when specifying a CH where an error occurred.
- \*3 Displayed when a tolerance setting error due to a key operation occurs.
- \*4 The error output format is CH\*\*,Error\$\$CRLF.
- \*5 Output when a tolerance setting error due to an RS command occurs.
- \*6 The parameter LED (1 or 6) corresponding to the error occurrence CH lights.
- \*7 A CH that does not have a gage connected as specified by the available axis designation parameter will also result in an error.
- \*8 The counter data inside the EV Counter is normal. When the counter data returns to the display range, it displays normally.
- \*9 Regardless of I/O logic, "H" is output when an error occurs.
- \*10 If the gage type parameter is set to 1 or 2 in the EV-16D, it will be automatically canceled.

## 7.2.2 Error Cancellation Method

The three main error cancellation methods are explained below, but the appropriate method differs depending on the cause.

- Automatic cancellation
- Press [P.SET].
- Input an external HOLD signal.

For details about error messages, see  "7.2.1 List of Error Codes" (page 76).

# 8 Specifications

## 8.1 Basic Specifications

Code No.	542-063	542-067	542-064
Sign	EV-16P	EV-16Z	EV-16D
Number of connected gages	6	6	6
Minimum reading	±999999.99 (10 μm) ±99999.995 (5 μm) ±99999.999 (1 μm) ±9999.9995 (0.5 μm) ±9999.9999 (0.1 μm)		Set automatically according to the gage.
Maximum input frequency	1.25 MHz (two-phase square wave) The response speed depends on the gage.		
Maximum count speed	5 MHz		
Power source voltage	DC +12 V–24 V, 700 mA, terminal block (M3 screw)		
Power consumption	8.4 W		
Operating temperature	0 °C–40 °C (20 % RH–80 % RH, without condensation)		
Storage temperature	-10 °C–50 °C (20 % RH–80 % RH, without condensation)		
External dimensions	144 (W) × 72 (H) × 139 (D) mm		
Mass	Approx. 910 g		Approx. 830 g
CE marking	EMC directive: EN61326-1 Immunity test requirements: Clause 6.2 Table 2 Emission limit: Class B RoHS directive EN50581		
Functions	Preset, Measurement mode switching (maximum value, minimum value, TIR value), tolerance output		
Interface	RS-232C / Digimatic / I/O		

## 8.2 External Dimensions Drawing (For All Models)

- EV Counter

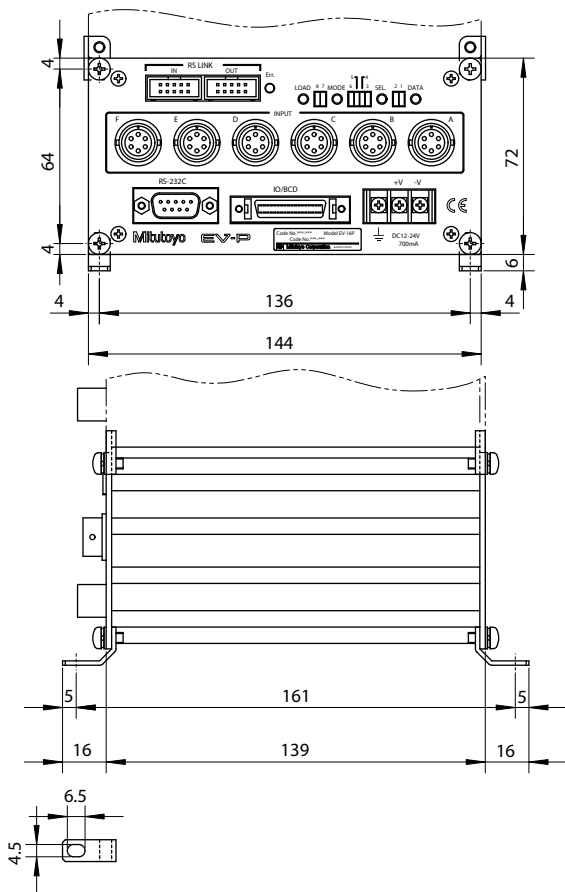

Unit: mm

## 8 Specifications

- D-EV External Display Unit (option)

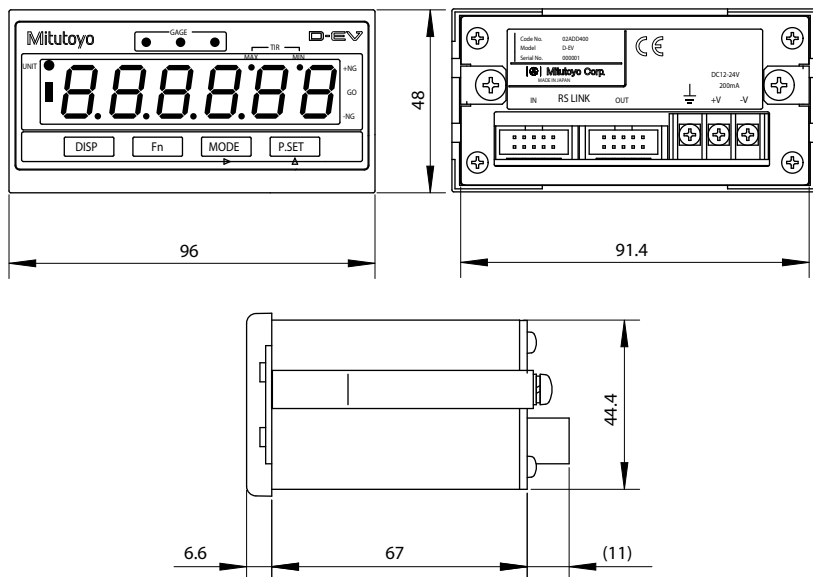

Unit: mm

### 8.3 Option

Part No.	Name
02ADD400	D-EV External Display Unit
02ADB440	Output connector (with cover)
02ADD950	Connection cable (RS LINK/Digimatic) (0.5 m)
936937	Connection cable (RS LINK/Digimatic) (1 m)
995014	Connection cable (RS LINK/Digimatic) (2 m)
02ADD930	Terminal strip connecting cable*
357651	AC adapter
02ZAA000	AC cable*

\* Required when using the AC adapter.

---

# SERVICE NETWORK

\*As of Sep. 2017

## Europe

### Mitutoyo Europe GmbH

Borsigstrasse 8-10, 41469 Neuss, GERMANY  
TEL: 49 (0)2137 102-0 FAX: 49 (0)2137 102-351

### Mitutoyo CTL Germany GmbH

Von-Gunzert-Strasse 17, 78727 Oberndorf,  
GERMANY  
TEL: 49 (0)7423 8776-0 FAX: 49 (0)7423 8776-99

### KOMEG Industrielle Messtechnik GmbH

Zum Wasserwerk 3, 66333 Völklingen, GERMANY  
TEL: 49 (0)6898 91110 FAX: 49 (0)6898 911100

## Germany

### Mitutoyo Deutschland GmbH

Borsigstrasse 8-10, 41469 Neuss, GERMANY  
TEL: 49 (0)2137 102-0 FAX: 49 (0)2137 86 85

### M3 Solution Center Hamburg

Tempowerkring 9-im HIT-Technologiepark 21079  
Hamburg, GERMANY  
TEL: 49 (0)40 791894-0 FAX: 49 (0)40 791894-50

### M3 Solution Center Berlin

Paradiesstrasse 208, 12526 Berlin, GERMANY  
TEL: 49(0)30 2611 267 FAX: 49(0)30 26 29 209

### M3 Solution Center Eisenach

Heinrich-Ehrhardt-Platz 1, 99817  
Eisenach, GERMANY  
TEL: 49 (0)3691 88909-0 FAX: 49 (0)3691 88909-9

### M3 Solution Center Ingolstadt

Marie-Curie-Strasse 1a, 85055 Ingolstadt,  
GERMANY  
TEL: 49 (0)841 954920 FAX: 49 (0)841 9549250

### M3 Solution Center Leonberg GmbH

Steinbeisstrasse 2, 71229 Leonberg, GERMANY  
TEL: 49 (0)7152 6080-0 FAX: 49 (0)7152 608060

### Mitutoyo-Messgeräte Leonberg GmbH

Heidenheimer Strasse 14, 71229 Leonberg,  
GERMANY  
TEL: 49 (0)7152 9237-0 FAX: 49 (0)7152 9237-29

## U.K.

### Mitutoyo (UK) Ltd.

Joule Road, West Point Business Park, Andover,  
Hampshire SP10 3UX, UNITED KINGDOM  
TEL: 44 (0)1264 353 123 FAX: 44 (0)1264 354883

### M3 Solution Center Coventry

Unit6, Banner Park, Wickmans Drive, Coventry,  
Warwickshire CV4 9XA, UNITED KINGDOM  
TEL: 44 (0)2476 426300 FAX: 44 (0)2476 426339

### M3 Solution Center Halifax

Lowfields Business Park, Navigation Close, Elland,  
West Yorkshire HX5 9HB, UNITED KINGDOM  
TEL: 44 (0)1422 375566 FAX: 44 (0)1422 328025

### M3 Solution Center East Kilbride

The Baird Bulding, Rankine Avenue, Scottish  
Enterprise Technology Park, East Killbride G75  
0QF, UNITED KINGDOM  
TEL: 44 (0)1355 581170 FAX: 44 (0)1355 581171

## France

### Mitutoyo France

Paris Nord 2-123 rue de la Belle Etoile, BP 59267  
ROISSY EN FRANCE 95957 ROISSY CDG  
CEDEX, FRANCE  
TEL: 33 (0)149 38 35 00

### M3 Solution Center LYON

Parc Mail 523, cours du 3ème millénaire, 69791  
Saint-Priest, FRANCE  
TEL: 33 (0)149 38 35 70

### M3 Solution Center STRASBOURG

Parc de la porte Sud, Rue du pont du péage,  
67118 Geispolsheim, FRANCE  
TEL: 33 (0)149 38 35 80

### M3 Solution Center CLUSES

Espace Scionzier 480 Avenue des Lacs, 74950  
Scionzier, FRANCE  
TEL: 33 (0)1 49 38 35 90

### M3 Solution Center TOULOUSE

12 rue de Caulet, Cellule B08, 31300 TOULOUSE,  
FRANCE  
TEL: 33 (0)1 49 38 42 90

### M3 Solution Center RENNES

ZAC Mivoie  
Le Vallon  
35230 Noyal-Châtillon sur Seiche, FRANCE  
TEL: 33 (0)1 49 38 42 10

---

---

## Italy

### **MITUTOYO ITALIANA S.r.l.**

Corso Europa, 7 - 20020 Lainate (MI), ITALY

TEL: 39 02 935781

FAX: 39 02 9373290-93578255

### **M3 Solution Center BOLOGNA**

Via dei Carpini 1/A - 40011 Anzola Emilia (BO), ITALY

TEL: 39 02 93578215 FAX: 39 02 93578255

### **M3 Solution Center CHIETI**

Contrada Santa Calcagna - 66020 Rocca S. Giovanni (CH), ITALY

TEL: 39 02 93578280 FAX: 39 02 93578255

### **M3 Solution Center PADOVA**

Via G. Galilei 21/F - 35035 Mestrino (PD), ITALY

TEL: 39 02 93578268 FAX: 39 02 93578255

## Belgium / Netherlands

### **Mitutoyo BeNeLux**

#### **Mitutoyo Belgium N.V.**

Hogenakkerhoekstraat 8, 9150 Kruikebe, BELGIUM

TEL: 32 (0)3-2540444 FAX: 32(0)3-2540445

#### **Mitutoyo Nederland B.V.**

Wiltonstraat 25, 3905 KW Veenendaal, THE NETHERLANDS

TEL: 31(0)318-534911

## Sweden

### **Mitutoyo Scandinavia AB**

Slåntvägen 6, 194 61 Upplands Väsby, SWEDEN

TEL: 46 (0)8 594 109 50 FAX: 46 (0)8 590 924 10

#### **M3 Solution Center Alingsås**

Ångsvaktaregatan 3A, 441 38 Alingsås, SWEDEN

TEL: 46 (0)8 594 109 50 FAX: 46 (0)322 63 31 62

#### **M3 Solution Center Värnamo**

Storgatsbacken 1, 331 30 Värnamo, SWEDEN

TEL: 46 (0)8 594 109 50 FAX: 46 (0)370 463 34

## Switzerland

### **Mitutoyo (Schweiz) AG**

Steinackerstrasse 35, 8902 Urdorf, SWITZERLAND

TEL: 41 (0)447361150 FAX: 41(0)447361151

### **Mitutoyo (Suisse) SA**

Rue Galilée 4, 1400 Yverdon-les Bains, SWITZERLAND

TEL: 41 (0)244259422 FAX: 41 (0)447361151

## Poland

### **Mitutoyo Polska Sp.z o.o.**

Ul.Graniczna 8A, 54-610 Wrocław, POLAND

TEL: 48 (0)71354 83 50 FAX: 48 (0)71354 83 55

## Czech Republic

### **Mitutoyo Česko s.r.o.**

Dubská 1626, 415 01 Teplice, CZECH REPUBLIC

TEL: 420 417-514-011 FAX: 420 417-579-867

#### **Mitutoyo Česko s.r.o. M3 Solution Center Ivančice**

Ke Karlovu 62/10, 664 91 Ivančice, CZECH REPUBLIC

TEL: 420 417-514-011 FAX: 420 417-579-867

#### **Mitutoyo Česko s.r.o. M3 Solution Center Ostrava Mošnov**

Mošnov 314, 742 51 Mošnov, CZECH REPUBLIC

TEL: 420 417-514-050 FAX: 420 417-579-867

#### **Mitutoyo Česko s.r.o. Slovakia Branch**

Hviezdoslavova 124, 017 01 Povážská Bystrica, SLOVAKIA

TEL: 421 948-595-590

## Hungary

### **Mitutoyo Hungária Kft.**

Záhony utca 7, D-épület / fsz, 1031 Budapest, HUNGARY

TEL: 36 (0)1 2141447 FAX: 36 (0)1 2141448

## Romania

### **Mitutoyo Romania SRL**

1A Drumul Garii Odai Street, showroom, Ground Floor, 075100 OTOPENI-ILFOV, ROMANIA

TEL: 40 (0)311012088 FAX: +40 (0)311012089

#### **Showroom in Brasov**

Strada Ionescu Crum Nr.1, Brasov Business Park Turmul 1, Mezanin, 500446 Brasov-Judetul Brasov, ROMANIA

TEL/FAX: 40 (0)371020017

## Russian Federation

### **Mitutoyo RUS LLC**

13 Sharikopodshipnikovskaya, bld.2, 115088 Moscow, RUSSIAN FEDERATION

TEL: 7 495 7450 752



---

## Finland

### Mitutoyo Scandinavia AB Finnish Branch

Viiherkiiittäjä 2A, 33960, Pirkkala, Finland  
TEL: 358 (0)40 355 8498

## Austria

### Mitutoyo Austria GmbH

Johann Roithner Straße 131 A-4050 Traun,  
AUSTRIA  
TEL: 43 (0)7229 23850 FAX: 43 (0)7229 23850-90

## Singapore

### Mitutoyo Asia Pacific Pte. Ltd.

#### Head office / M3 Solution Center

24 Kallang Avenue, Mitutoyo Building,  
SINGAPORE 339415  
TEL: (65)62942211 FAX: (65)62996666

## Malaysia

### Mitutoyo (Malaysia) Sdn. Bhd.

#### Kuala Lumpur Head Office / M3 Solution Center

Mah Sing Intergrated Industrial Park, 4, Jalan  
Utariid U5/14, Section U5, 40150 Shah Alam,  
Selangor, MALAYSIA

TEL: (60)3-78459318 FAX: (60)3-78459346

#### Penang Branch office / M3 Solution Center

No.30, Persiaran Mahsuri 1/2, Sunway Tunas,  
11900 Bayan Lepas, Penang, MALAYSIA  
TEL: (60)4-6411998 FAX: (60)4-6412998

#### Johor Branch office / M3 Solution Center

No. 70, Jalan Molek 1/28, Taman Molek, 81100  
Johor Bahru, Johor, MALAYSIA  
TEL: (60)7-3521626 FAX: (60)7-3521628

## Thailand

### Mitutoyo(Thailand)Co., Ltd.

#### Bangkok Head Office / M3 Solution Center

76/3-5, Chaengwattana Road, Kwaeng  
Anusaowaree, Khet Bangkaen, Bangkok 10220,  
THAILAND

TEL: (66)2-080-3500 FAX: (66)2-521-6136

#### Chonburi Branch / M3 Solution Center

7/1, Moo 3, Tambon Bowin, Amphur Sriracha,  
Chonburi 20230, THAILAND

TEL: (66)2-080-3563 FAX: (66)3-834-5788

#### Amata Nakorn Branch / M3 Solution Center

700/199, Moo 1, Tambon Bankao, Amphur  
Phanthong, Chonburi 20160, THAILAND  
TEL: (66)2-080-3565 FAX: (66)3-846-8978

## Indonesia

### PT. Mitutoyo Indonesia

#### Head Office / M3 Solution Center

Jalan Sriwijaya No.26 Desa cibatu Kec. Cikarang  
Selatan Kab. Bekasi 17530, INDONESIA  
TEL: (62)21-2962 8600 FAX: (62)21-2962 8604

## Vietnam

### Mitutoyo Vietnam Co., Ltd

#### Hanoi Head Office / M3 Solution Center

No. 07-TT4, My Dinh - Me Tri Urban Zone, My Dinh  
1 Ward, Nam Tu Liem District, Hanoi, VIETNAM  
TEL: (84)4-3768-8963 FAX: (84)4-3768-8960

#### Ho Chi Minh City Branch Office / M3 Solution Center

123 Dien Bien Phu Street, Ward 15, Binh Thanh  
District, Ho Chi Minh City, VIETNAM  
TEL: (84)8-3840-3489 FAX: (84)8-3840-3498

## Mitutoyo Philippines, Inc.

### Head Office / M3 Solution Center

Unit 2103, Bldg 2 GMV Building 2, 107 North Main  
Avenue, Laguna Technopark, Binan, Laguna 4024,  
Philippines  
TEL: (63)49 544 0272 FAX: (63)49 544 0272

## India

### Mitutoyo South Asia Pvt. Ltd.

#### Head Office / M3 Solution Center

C-122, Okhla Industrial Area, Phase-I, New  
Delhi-110 020, INDIA

TEL: 91(11)2637-2090 FAX: 91(11)2637-2636

#### MSA Gurgaon technical center

Plot No. 65, Phase-IV, Udyog Vihar, Gurgaon –  
122016

TEL: 91 (0124) – 2340294

#### Mumbai Region Head office

303, Sentinel Hiranandani Business Park Powai,  
Mumbai-400 076, INDIA

TEL: 91(22)2570-0684, 837, 839 FAX: 91(22)2570-  
06859

FAX: 91(22)2570-0685

#### Pune Office / M3 Solution Center

G2/G3, Pride Kumar Senate, F.P. No. 402 Off.  
Senapati Bapat Road, Pune-411 016, INDIA

TEL: 91(20)6603-3643, 45, 46

FAX: 91(20)6603-3644

---

---

**Vadodara office**

S-1&S-2, Olive Complex, Nr. Haveli, Nizampura,  
Vadodara-390 002, INDIA

TEL: 91 265-2750781 FAX: (91) 265-2750782

**Bengaluru Region Head office / M3 Solution Center**

No. 5, 100 Ft. Road, 17th Main, Koramangala, 4th  
Block, Bengaluru-560 034, INDIA

TEL: 91(80)2563-0946, 47, 48

FAX: 91(80)2563-0949

**Chennai Office / M3 Solution Center**

No. 624, Anna Salai Teynampet, Chennai-600 018,  
INDIA

TEL: 91(44)2432-8823, 24, 27, 28

FAX: 91(44)2432-8825

**Kolkata Office**

Unit No. 1208, Om Tower, 32, J.L..Nehru Road,  
Kolkata-700 071, INDIA

TEL: 91 33-22267088/40060635

FAX: (91) 33-22266817

**Taiwan****Mitutoyo Taiwan Co., Ltd. / M3 Solution Center Taipei**

4F., No.71, Zhouyi St., Neihu Dist., Taipei City 114,  
TAIWAN (R.O.C.)

TEL: 886(2)5573-5902 FAX: 886(2)8752-3267

**Taichung Branch / M3 Solution Center Taichung**

1F., No.758, Zhongming S. Rd., South Dist.,  
Taichung City 402, TAIWAN(R.O.C.)

TEL: 886(4)2262-9188 FAX: 886(4) 2262-9166

**Kaohsiung Branch / M3 Solution Center Kaohsiung**

1F., No.31-1, Haibian Rd., Lingya Dist., Kaohsiung  
City 802, Taiwan (R.O.C.)

TEL: 886(7)334-6168 FAX: 886(7)334-6160

**South Korea****Mitutoyo Korea Corporation****Head Office / M3 Solution Center**

(Sanbon-Dong, Geumjeong High View Build.),  
6F, 153-8, Ls-Ro, Gunpo-Si, Gyeonggi-Do, 15808  
KOREA

TEL: 82(31)361-4200 FAX: 82(31)361-4202

**Busan Office / M3 Solution Center**

(3150-3, Daejeo 2-dong) 8, Yutongdanji 1-ro  
49beon-gil, Gangseo-gu, Busan, 46721 KOREA

TEL: 82(51)718-2140 FAX: 82(51)324-0104

**Daegu Office / M3 Solution Center**

371-12, Hosan-Dong, Dalseo-Gu, Daegu, 42704,  
KOREA

TEL: 82(53)593-5602 FAX: 82(53)593-5603

**China****Mitutoyo Measuring Instruments (Shanghai) Co., Ltd.**

12F, Nextage Business Center, No.1111 Pudong  
South Road, Pudong New District, Shanghai  
200120, CHINA

TEL: 86(21)5836-0718 FAX: 86(21)5836-0717

**Suzhou Office / M3 Solution Center (Suzhou)**

No. 46 Baiyu Road, Suzhou 215021, CHINA

TEL: 86(512)6522-1790 FAX: 86(512)6251-3420

**Wuhan Office**

Room 1701, Wuhan Wanda Center, No. 96,  
Linjiang Road, Wuchang District, Wuhan Hubei  
430060, CHINA

TEL: 86(27)8544-8631 FAX: 86(27)8544-6227

**Chengdu Office**

1-701, New Angle Plaza, 668# Jindong Road,  
Jinjiang District, Chengdu, Sichuan 610066, CHINA

TEL: 86(28)8671-8936 FAX: 86(28)8671-9086

**Hangzhou Office**

Room 804, Eastern International Business Center  
Building 1, No.600 Jinsha Road

Hangzhou Economic and Technological  
Development Zone, 310018, China

TEL: 86(571)8288-0319 FAX: 86(571)8288-0320

**Tianjin Office / M3 Solution Center Tianjin**

Room A 15/F, TEDA Building, No.256 Jie-fang Nan  
Road Hexi District, Tianjin 300042, CHINA

TEL: 86(22)5888-1700 FAX: 86(22)5888-1701

**Changchun Office**

Room 815, 8F, Building A1, Upper East  
International No.3000 Dongsheng Street, Erdao  
District, Changchun, Jilin, 130031, CHINA

TEL: 86(431)8192-6998 FAX: 86(431)8192-6998

---

---

**Chongqing Office**

Room 1312, Building 3, Zhongyu Plaza, No.86,  
Hongjin Avenue, Longxi Street, Yubei District,  
Chongqing, 400000, CHINA

TEL: 86(23)6595-9950 FAX: 86(23)6595-9950

**Qingdao Office**

Room 638, 6F, No.192 Zhengyang Road,  
Chengyang District, Qingdao, Shandong, 266109,  
CHINA

TEL: 86(532)8096-1936 FAX: 86(532)8096-1937

**Xi'an Office**

Room 805, Xi'an International Trade Center,  
No. 196 Xiaozhai East Road, Xi'an, 710061, CHINA

TEL: 86(29)8538-1380 FAX: 86(29)8538-1381

**Dalian Office / M3 Solution Center Dalian**

Room 1008, Grand Central IFC, No.128 Jin ma  
Road, Economic Development Zone, Dalian  
116600, CHINA

TEL: 86(411)8718 1212 FAX: 86(411)8754-7587

**Zhengzhou Office**

Room1801,18/F,Unit1,Building No.23,  
Shangwu Inner Ring Road, Zhengdong New  
District,Zhengzhou City, Henan Province,  
450018,CHINA

TEL: 86(371)6097-6436 FAX: 86(371)6097-6981

**Mitutoyo Leeport Metrology (Hong Kong)  
Limited**

Room 818, 8/F, Vanta Industrial Centre, No.21-33,  
Tai Lin Pai Road, Kwai Chung, NT, Hong Kong

TEL: 86(852)2992-2088 FAX: 86(852)2670-2488

**Mitutoyo Leeport Metrology (Dongguan)  
Limited / M3 Solution Center Dongguan**

No.26, Guan Chang Road, Chong Tou Zone,  
Chang An Town, Dong Guan, 523855 CHINA

TEL: 86(769)8541 7715 FAX: 86(769)-8541 7745

**Mitutoyo Leeport Metrology (Dongguan)  
Limited – Fuzhou office**

Room 2104, City Commercial Centre, No.129 Wu Yi  
Road N., Fuzhou City, Fujian Province, CHINA

TEL: 86 591 8761 8095 FAX: 86 591 8761 8096

**Mitutoyo Leeport Metrology (Dongguan)  
Limited – Changsha office**

Room 2207, Shiner International Plaza, No. 88,  
Kaiyuan Middle Road, Changsha City, Hunan,  
China

TEL: 86 731 8401 9276 FAX: 86 731 8401 9376

**Mitutoyo Measuring Instruments (Suzhou) Co.,  
Ltd.**

No. 46 Baiyu Road, Suzhou 215021, CHINA

TEL: 86(512)6252-2660 FAX: 86(512)6252-2580

**U.S.A.****Mitutoyo America Corporation**

965 Corporate Boulevard, Aurora, IL 60502, U.S.A.

TEL: 1-(630)820-9666

Toll Free No. 1-(888)648-8869

FAX: 1-(630)978-3501

**M3 Solution Center-Illinois**

965 Corporate Boulevard, Aurora, IL 60502, U.S.A.

TEL: 1-(888)648-8869 FAX: 1-(630)978-3501

**M3 Solution Center-Ohio**

6220 Hi-Tek Court, Mason, OH 45040, U.S.A.

TEL: 1-(888)648-8869 FAX: 1-(513)754-0718

**M3 Solution Center-Michigan**

46850 Magellan Drive, Suite 100, Novi, MI 48377,  
U.S.A.

TEL: 1-(888)648-8869 FAX: 1-(248)926-0928

**M3 Solution Center-California**

16925 E. Gale Avenue, City of Industry, CA 91745,  
U.S.A.

TEL: 1-(888)648-8869 FAX: 1-(626)369-3352

**M3 Solution Center-North Carolina**

11515 Vanstory Drive, Suite 140, Huntersville, NC  
28078, U.S.A.

TEL: 1-(888)648-8869 FAX: 1-(704)875-9273

**M3 Solution Center-Alabama**

2100 Riverchase Center, Suite 106, Hoover, AL  
35244, U.S.A

TEL: 1-(888)648-8869 FAX: s1-(205)988-3423

**M3 Solution Center-Washington**

1000 SW 34th Street Suite G, Renton WA 98057  
U.S.A.

TEL: 1-(888)648-8869

**M3 Solution Center-Texas**

4560 Kendrick Plaza Drive, Suite 120, Houston, TX  
77032, U.S.A.

TEL: 1-(888)648-8869 FAX: 1-(281)227-0937

**M3 Solution Center-Massachusetts**

753 Forest Street, Suite 110, Marlborough,MA  
01752, U.S.A.

TEL: 1-(888)648-8869 FAX: 1-(508)485-0782

**Mitutoyo America Corporation Calibration Lab**

965 Corporate Boulevard, Aurora, IL 60502, U.S.A.

TEL: 1-(888)648-8869 FAX: 1-(630)978-6477

**Micro Encoder, Inc.**

11533 NE 118th Street, Kirkland, WA 98034, U.S.A.

TEL: 1-(425)821-3906 FAX: 1-(425)821-3228

---

---

**Micro Encoder Los Angeles, Inc.**

16925 E. Gale Avenue, City of Industry, CA 91745  
U.S.A.  
TEL: 1-(626)271-1075

**Canada****Mitutoyo Canada Inc.**

2121 Meadowvale Blvd., Mississauga, Ont. L5N  
5N1., CANADA

TEL: 1-(905)821-1261 FAX: 1-(905)821-4968

**Montreal Office**

7075 Place Robert-Joncas Suite 129, Montreal,  
Quebec H4M 2Z2, CANADA

TEL: 1-(514)337-5994 FAX: 1-(514)337-4498

**Brazil****Mitutoyo Sul Americana Ltda.**

Rodovia Índio Tibiriça 1555, Bairro Raffo, CEP  
08620-000 Suzano – SP, Brasil

TEL: 55 (11)4746-5858

**Argentina****Mitutoyo Sul Americana Ltda.****Argentina Branch**

Av. B. Mitre 891/899 – C.P. (B1603CQI) Vicente  
López –Pcia. Buenos Aires – Argentina

TEL: 54(11)4730-1433 FAX: 54(11)4730-1411

**Sucursal Cordoba**

Av. Amadeo Sabattini, 1296, esq. Madrid B° Crisol  
Sur – CP 5000, Cordoba, ARGENTINA

TEL/FAX: 54 (351) 456-6251

**Mexico****Mitutoyo Mexicana, S.A. de C.V.**

Prolongación Industria Eléctrica No. 15 Parque  
Industrial Naucalpan

Naucalpan de Juárez, Estado de México C.P.  
53370, MÉXICO

TEL: 52 (01-55) 5312-5612

**Monterrey Office/ M3 Solution Center Monterrey**

Av. Morones Prieto No 914, Oriente Local, 105  
Plaza Matz

Col. La Huerta, C.P. 67140 Guadalupe, N.L.,  
MÉXICO

TEL: 52 (01-81) 8398-8227, 8398-8228, 8398-  
8244, 8398-8245 and 8398-8246

FAX: 52 (01-81) 8398-8245

**Tijuana Office/ M3 Solution Center Tijuana**

Av. 2o. eje Oriente-Poniente No. 19075 Int. 18 Col.  
Cd. Industrial Nueva Tijuana C.P. 22500 Tijuana, B.  
C., MÉXICO

TEL: 52 (01-664) 647-5024

**Querétaro Office / M3 Solution Center  
Querétaro**

Av. Cerro Blanco No.500-1, Colonia Centro Sur,  
Querétaro, Querétaro, C.P. 76090, MÉXICO

TEL: 52 (01-442) 340-8018, 340-8019 and 340-  
8020

FAX: 52 (01-442) 340-8017

**Mitutoyo Mexicana, S.A. de C.V. Querétaro  
Calibration Laboratory**

Av. Cerro Blanco 500 30 Centro Sur, Querétaro,  
Querétaro, C.P. 76090, MÉXICO

TEL: 52 (01-442) 340-8018, 340-8019 and 340-  
8020

FAX: 52 (01-442) 340-8017

**Aguascalientes Office / M3 Solution Center**

Av. Aguascalientes No. 622, Local 15 Centro  
Comercial El Cilindro Fracc. Pulgas Pandas Norte,  
C.P. 20138, Aguascalientes, Ags. MÉXICO

TEL: 52 (01-449) 174-4140 and 174-4143

**Irapuato Office / M3 Solution Center**

Boulevard a Villas de Irapuato No. 1460 L.1 Col.  
Ejido

Irapuato C.P. 36643

Irapuato, Gto., MÉXICO

TEL: 52 (01-462) 144-1200 and 144-1400

---

---

## Revision History

Date of publication	No. of revisions	Revision details
January 1, 2018	Seventh edition	Printed

## **Mitutoyo Corporation**

---

20-1, Sakado 1-Chome, Takatsu-ku, Kawasaki-shi, Kanagawa 213-8533, Japan  
Tel: +81 (0)44 813-8230 Fax: +81 (0)44 813-8231  
Home page: <http://www.mitutoyo.co.jp/global.html>

For the EU Directive, Authorized representative and importer in the EU:  
Mitutoyo Europe GmbH  
Borsigstrasse 8-10, 41469 Neuss, Germany

Printed in Japan